

Grandstream Networks, Inc.

GXV3240

IP Multimedia Phone for Android™

Administration Guide



COPYRIGHT

©2019 Grandstream Networks, Inc. <http://www.grandstream.com>

All rights reserved. Information in this document is subject to change without notice. Reproduction or transmittal of the entire or any part, in any form or by any means, electronic or print, for any purpose without the express written permission of Grandstream Networks, Inc. is not permitted.

The latest electronic version of this guide is available for download here:

<http://www.grandstream.com/support>

Grandstream is a registered trademark and Grandstream logo is trademark of Grandstream Networks, Inc. in the United States, Europe and other countries.

CAUTION

Changes or modifications to this product not expressly approved by Grandstream, or operation of this product in any way other than as detailed by this guide, could void your manufacturer warranty.

WARNING

Please do not use a different power adaptor with devices as it may cause damage to the products and void the manufacturer warranty.



FCC Caution

Any Changes or modifications not expressly approved by the party responsible for compliance could void the user's authority to operate the equipment. This device complies with part 15 of the FCC Rules. Operation is subject to the following two conditions: (1) This device may not cause harmful interference, and (2) this device must accept any interference received, including interference that may cause undesired operation.

Note: This equipment has been tested and found to comply with the limits for a Class B digital device, pursuant to part 15 of the FCC Rules. These limits are designed to provide reasonable protection against harmful interference in a residential installation. This equipment generates uses and can radiate radio frequency energy and, if not installed and used in accordance with the instructions, may cause harmful interference to radio communications. However, there is no guarantee that interference will not occur in a particular installation. If this equipment does cause harmful interference to radio or television reception, which can be determined by turning the equipment off and on, the user is encouraged to try to correct the interference by one or more of the following measures:

- Reorient or relocate the receiving antenna.
- Increase the separation between the equipment and receiver.
- Connect the equipment into an outlet on a circuit different from that to which the receiver is connected.
- Consult the dealer or an experienced radio/TV technician for help.

RF Exposure Information (SAR)

This device is designed and manufactured not to be exceeded the emission limits for exposure to radio frequency RF energy set by the Federal Communications Commission of the United States. The exposure standard for wireless devices employing a unit of measurement is known as the Specific Absorption Rate (SAR), and the SAR limit set by FCC is 1.6 W/kg.

This device is complied with SAR for general population/uncontrolled exposure limits in ANSI/IEEE C95.1-1992, and has been tested in accordance with the measurement methods and procedures specified in OET Bulletin 65 Supplement C. This device has been tested, and meets the FCC RF exposure guidelines when tested with the device directly contacted to the body. RF exposure compliance with anybody-worn accessory, which contains metal, was not tested and certified, and use such body-worn accessory should be avoided.

Changes or modifications not expressly approved by the party responsible for compliance could void the user's authority to operate the equipment.

Hereby, Grandstream declares that this device is in compliance with the essential requirements and other relevant provisions of Directive 1999/5/EC.



GNU GPL INFORMATION

GXV3240 firmware contains third-party software licensed under the GNU General Public License (GPL). Grandstream uses software under the specific terms of the GPL. Please see the GNU General Public License (GPL) for the exact terms and conditions of the license.

Grandstream GNU GPL related source code can be downloaded from Grandstream web site from:

http://www.grandstream.com/sites/default/files/Resources/gxv32xx_gpl.zip



Table of Contents

DOCUMENT PURPOSE	11
CHANGE LOG	12
Firmware Version 1.0.3.224	12
Firmware Version 1.0.3.219	12
Firmware Version 1.0.3.210	12
Firmware Version 1.0.3.207	12
Firmware Version 1.0.3.198	12
Firmware Version 1.0.3.193	12
Firmware Version 1.0.3.187	13
Firmware Version 1.0.3.186	13
Firmware Version 1.0.3.180	13
Firmware Version 1.0.3.177	14
Firmware Version 1.0.3.171	14
Firmware Version 1.0.3.162	14
Firmware Version 1.0.3.158	14
Firmware Version 1.0.3.144	14
Firmware Version 1.0.3.131	15
Firmware Version 1.0.3.92	16
Firmware Version 1.0.3.75	16
Firmware Version 1.0.3.62	16
Firmware Version 1.0.3.55	16
Firmware Version 1.0.3.46	16
Firmware Version 1.0.3.37	16
Firmware Version 1.0.3.30	17
Firmware Version 1.0.3.22	18
Firmware Version 1.0.3.6.....	18
Firmware Version 1.0.1.54	18
Firmware Version 1.0.1.39	19
Firmware Version 1.0.1.29	19
WELCOME	20
PRODUCT OVERVIEW	21



Feature Highlights	21
GXV3240 Technical Specifications	22
GETTING STARTED	24
Equipment Packaging	24
GXV3240 Phone Setup	25
<i>Using the Phone Stand</i>	25
<i>Using the Slots for Wall Mounting</i>	25
Connecting the GXV3240	26
GXV3240 LCD SETTINGS	27
Open LCD Settings	29
Personalized Account	29
Wireless & Network	30
<i>Ethernet Settings</i>	31
<i>Wi-Fi Settings</i>	31
<i>Bluetooth Settings</i>	32
<i>VPN</i>	33
<i>Proxy Settings</i>	33
<i>Additional Network Settings</i>	33
<i>Tethering & Portable Hotspot</i>	34
Sound	35
Display	35
Storage	36
Applications	37
<i>View Applications</i>	37
<i>Manage Applications</i>	38
Location Access	38
Security Settings	38
<i>Screen Security</i>	38
<i>Passwords</i>	39
<i>Device Administration</i>	39
<i>Credential Storage</i>	39
Language & Keyboard	39
Accounts	40
Register to Failover SIP Server	41



Date & Time.....	42
Accessibility.....	42
About Phone.....	42
Advanced Settings.....	42
Multicast Paging.....	44
GXV3240 WEB GUI SETTINGS.....	45
Access GXV3240 Web GUI.....	45
Saving Changes.....	46
Definitions.....	46
Toolbar.....	47
Click-To-Dial.....	47
Status Page Definitions.....	48
<i>Status/Account Status</i>	48
<i>Status/Network Status</i>	48
<i>Status/System Info</i>	49
Account Page Definitions.....	49
<i>Account/General Settings</i>	49
<i>Account/Network Settings</i>	50
<i>Account/SIP Settings</i>	52
<i>Account/Codec Settings</i>	57
<i>Account/Call Settings</i>	61
Advanced Settings Page Definitions.....	68
<i>Advanced Settings/General Settings</i>	68
<i>Advanced Settings/Call Features</i>	70
<i>Advanced Settings/Video Settings</i>	74
<i>Advanced Settings/Tone Generator</i>	75
<i>Advanced Settings/Multicast Paging</i>	75
<i>Advanced Settings/GDS Settings</i>	76
<i>Advanced Settings/MPK General Settings</i>	77
<i>Advanced Settings/MPK LCD Settings</i>	77
<i>Advanced Settings/MPK EXT Settings (For GXV3240 Ext Board 1/2/3/4)</i>	78
Maintenance Page Definitions.....	79
<i>Maintenance/Network Settings</i>	79
<i>Maintenance/Wi-Fi Settings</i>	83
<i>Maintenance/Time Settings</i>	83



<i>Maintenance/Web/SSH Access</i>	84
<i>Maintenance/Upgrade</i>	84
<i>Maintenance/Syslog</i>	88
<i>Maintenance/Logcat</i>	89
<i>Maintenance/Debug</i>	89
<i>Maintenance/Language</i>	90
<i>Maintenance/Event Notification</i>	90
<i>Maintenance/TR-069</i>	91
<i>Maintenance/Contacts</i>	92
<i>Maintenance/LDAP Book</i>	94
<i>Maintenance/Broadsoft Directories</i>	96
<i>Maintenance/Broadsoft IM&P</i>	97
<i>Maintenance/Device Manager</i>	97
Reboot	101
UPGRADING AND PROVISIONING	102
Upgrade and Provisioning Configuration	102
Upload Firmware Locally	103
Upgrade via SD Card	104
No Local Firmware Servers	105
Provisioning and Configuration File Download	105
BACKUP	106
Generate Backup File	106
Restore from Backup File	107
Automatic Backup	108
DATA WIPING	109
FACTORY RESET	110
Restore to Factory Default via LCD Menu	110
Restore to Factory Default via the Web GUI	111
Restore to Factory Default via Hard Keys	111
SAFE MODE	112
EXPERIENCING THE GXV3240 APPLICATION PHONE	113



Table of Tables

Table 1: GXV3240 Features in a Glance	21
Table 2: GXV3240 Technical Specifications.....	22
Table 3: Equipment Packaging	24
Table 4: GXV3240 LCD Settings.....	27
Table 5: GXV3240 Storage Category and Actions	37
Table 6: GXV3240 Web Access	47



Table of Figures

Figure 1: GXV3240 Package Content.....	24
Figure 2: Slots for the Wall Mount and Phone Stand on the GXV3240.....	25
Figure 3: Tab on the Handset Cradle	25
Figure 4: GXV3240 Back View.....	26
Figure 5: GXV3240 System Settings	29
Figure 6: GXV3240 Bluetooth Settings	32
Figure 7: GXV3240 Bluetooth Paired Device Settings	33
Figure 8: GXV3240 Wi-Fi Hotspot	35
Figure 9: GXV3240 Storage.....	36
Figure 10: Erase SD Card.....	37
Figure 11: GXV3240 Accounts Sync Up Settings - Google Account Signed In	40
Figure 12: GXV3240 Accounts Sync Up Settings - Google Account Synced Up	40
Figure 13: GXV3240 Accounts Sync up Settings - Select Browser, Calendar and Contacts	41
Figure 14: GXV3240 Google Play Account.....	41
Figure 15: GXV3240 UCM Auto Config Number – Select Registering Numbers	43
Figure 16: GXV3240 UCM Auto Config Number – Enabling Registering Number	43
Figure 17: GXV3240 Web GUI - Login	45
Figure 18: GXV3240 Main Screen - IP Address	45
Figure 19: GXV3240 Web UI Tool Bar	47
Figure 20: Click to Dial Feature	47
Figure 21: Click to Dial Menu and Calls Status.....	48
Figure 22: Reboot Button	101
Figure 23: GXV3240 Upgrade Configuration via LCD	102
Figure 24: GXV3240 Upgrade Configuration via Web GUI	103
Figure 25: Firmware Upgrade	104
Figure 26: GXV3240 Backup	106
Figure 27: Select Backup Applications.....	106
Figure 28: Select Backup Applications to Be Restored	107
Figure 29: Restore Process	107
Figure 30: Automatic Backup Settings	108
Figure 31: Data Wiping	109
Figure 32: Reboot Confirmation Message	109
Figure 33: GXV3240 LCD - Factory Reset	110
Figure 34: GXV3240 LCD - Confirm Factory Reset.....	110
Figure 35: GXV3240 Web GUI - Factory Reset.....	111
Figure 36: GXV3240 Web GUI - Confirm Factory Reset	111



DOCUMENT PURPOSE

This document describes how to configure the GXV3240 via phone's LCD menu and web UI menu to fully manipulate phone's features. The intended audiences of this document are VoIP administrators. To learn the basic functions of the GXV3240, please visit <http://www.grandstream.com/support> to download the latest "GXV3240 User Guide".

This guide covers following topics:

- [Product Overview](#)
- [Getting Started](#)
- [GXV3240 LCD Settings](#)
- [GXV3240 Web GUI Settings](#)
- [Upgrading and provisioning](#)
- [Backup](#)
- [Data Wiping](#)
- [Restore factory default settings](#)
- [Safe Mode](#)
- [Experiencing the GXV3240 applications](#)



CHANGE LOG

This section documents significant changes from previous versions of administration guide for GXV3240. Only major new features or major document updates are listed here. Minor updates for corrections or editing are not documented here.

Firmware Version 1.0.3.224

- Added support to auto answer the call based on SIP UPDATE message. [Auto Answer]
- Added support to enable/disable preview for incoming Baudisch call. [Enable preview]

Firmware Version 1.0.3.219

- Added support to transfer a call via MPK BLF button. [Transfer via non-Transfer Programmable Key]
- Added support for the device to synchronize the contact via SIP NOTIFY message. [Sync Phonebook via SIP Notify]
- Added RTP Timeout Timer for account. [RTP Timeout Timer]

Firmware Version 1.0.3.210

- Added support of TLS 1.2 version. [GXV3240 Technical Specifications]
- Added volume lock setting to avoid volume adjustment by users. [Advanced Settings/Tone Generator]
- Added ability to display the information from Diversion header. [Enable Diversion Info Display]

Firmware Version 1.0.3.207

- Added Accessibility Settings in LCD Settings. [Accessibility]

Firmware Version 1.0.3.198

- Changed "No Key Entry Timeout" interval to 0-30 (0 is disabled) [No Key Entry Timeout]
- Added Dutch language. [Multi-language] [Maintenance/Language]

Firmware Version 1.0.3.193

- Added new "Maintenance → Upgrade → Configuration via Keypad Menu", option: "Basic Settings & Network Settings. [Configuration via Keypad Menu]
- Supported adding custom CA certificate to device under Web UI → Advanced Settings → General Settings. [Custom Certificate]
- Supported P-Access-Network-Info Header and P-Emergency-Info Header in Web UI → Account → SIP Settings. [Use P-Access-Network-Info Header]
- Added more entries for Baudisch door system feature. Now it supports 100 entries. [Baudisch Door System URL]
- Supported displaying DTMF programmable key in call screen under Baudisch door system feature.



- Added an option to show the call menu or not after receiving an audio call under Baudisch door system feature.
- Added P-values for “Account → Call Settings → Auto Preview”.
- Support provision would start without reboot if HTTP/HTTPS username/password are updated. [without reboot]
- Added “Debug → Download Log” option for downloading dmesg, logcat and syslog, and removed logcat page. [Download Log]
- Added space character to “Advanced Settings → Call Features → Filter Characters”. [Filter Characters]
- Updated the “Account → Codec Settings → Packetization Mode” options. [Packetization Mode]
- Supported allow device to receive multicast paging when DND is enabled. [Allow Multicast in DND Mode]

Firmware Version 1.0.3.187

- Replaced expired pem certificate
- Supported auto record under web UI → Advanced Settings → Call Features → Enable Auto Record When Call Established. [Auto Record]
- Supported web UI → Advanced Settings → Call Features → Hold Call Before Completing Transfer. [Hold Call Before Completing Transfer]
- Updated the copyright statement to 2018 in WebUI.

Firmware Version 1.0.3.186

- Added Bluetooth patch for BlueBorne vulnerability.
- Added the option Play warning tone for Auto Answer Intercom. [Play warning tone for Auto Answer Intercom]
- Supported TLSv1.1 and TLSv1.2.
- Added option to allow device to ring when “Auto Preview” is enabled. [Auto Preview]
- Added support for displaying more Programmable keys in call interface. [Programmable Keys]
- Added support for auto downloading firmware/config randomly in time window. [Automatic Upgrade]
- Removed icon for reboot from web UI → Advanced Settings → General Settings → “STUN Server”, “Use NAT IP” and “SIP TLS Private Key” settings. [General Settings]
- Added support for removing previous upgrade notification bar when doing manual upload upgrading. [Upload Firmware Locally]
- Added admin authentication for factory reset if Configuration via Keypad Menu is set to “Basic settings only” or “Constraint mode”. The input will take effect after about 10 seconds of input [Configuration via Keypad Menu]

Firmware Version 1.0.3.180

- Added the option to remove the Register's Authorization header after the first successful register [Add Auth Header On RE-REGISTER].
- Supported new config file format: cfggxv3240.xml.



- Updated that previewing an incoming video call will display DTMF programmable key.

Firmware Version 1.0.3.177

- Added support for Syslog over SSL/TLS. [Syslog Protocol]
- Added option for DNS SRV Failover mode [DNS SRV Fail-over Mode]
- Added option to set call forward when phone is set to DND. [Forward when DND]
- Updated to enable automatically trim the account name and display name on web UI. [Account Name]

Firmware Version 1.0.3.171

- Added sending SIP INFO message with “record” header when record key is pressed. [Record Mode]
- Added “Record Mode” to specify the location for saving call recording. [Record Mode]
- Added “In Call Dial Number on Pressing Transfer Key” to configure the number to be dialed as DTMF when using transfer button. [In-Call Dial Number on Pressing Transfer Key]
- Added support for displaying the account name on Click-To-Dial page. [Click-To-Dial]

Firmware Version 1.0.3.162

- Added “Ignore Alert-Info header”. [Ignore Alert-Info header]
- Added “Disable RJ9 Headset Auto Detect”. [Disable RJ9 Headset Auto Detect]
- Added support for HTTP URL authentication when challenged by camera for getting MJPEG stream. [Special Feature]
- Added support to SIP register to failover SIP server. [Register to Failover SIP Server]
- Added support to user secondary SIP server for guest login. [Guest Login]
- Added support for GDS3710 integration. [Advanced Settings/GDS Settings]

Firmware Version 1.0.3.158

- Added Account → Call Settings → Intercom barging. [Intercom Barging]
- Added support ‘{’, ‘}’ as valid character in Maintenance → Contacts → Download Server. [Download Server]
- Added “Constraint Mode” in Maintenance → Upgrade → Configuration via Keypad Menu. [Configuration via Keypad Menu]
- Updated preview function before answering the call would keep playing ringback on caller side. [Enable Function for Incoming Call]
- Improving changing syslog level does not need reboot to take effect. [Syslog]
- Added “Data Wiping” in LCD Settings. [Data Wiping]
- Added support of SNI extension for TLS. [SNI]
- Updated the default NTP server. [Assign NTP Server Address]

Firmware Version 1.0.3.144

- Improved web UI security by avoiding reading/writing cookie.



- Improved the utility of “Use # as Dial Key” to dial out. [Use # as Dial Key]
- Added new option “Dial Prefix” under MPK Ext Settings → Key Mode. [Key Mode]
- Added support of “Click to Dial” feature on web GUI. [Click-To-Dial]
- Set DHCP VLAN Override to “Encapsulated in DHCP Option 43” by default. [DHCP VLAN Override]
- Added support of sending only SIP log under syslog settings. [Syslog]
- Added “Enable Enterprise Contacts Timeout Auto Search”. [Enable Enterprise Contacts Timeout Auto Search]
- Removed “Jitter Buffer Maximum (ms)” option from codec settings.
- Added option “Custom Alert-Info for Auto Answer”. [Custom Alert-Info for Auto Answer]
- Set default value for option “Handset TX gain(dB)” to “-6”. [Handset TX Gain (dB)]
- Set default value for option “Handset Equalizer RX” to “Fidelity”. [Handset Equalizer RX]
- Added “Attended Transfer Only” to Default Transfer Mode. [Default Transfer Mode]

Firmware Version 1.0.3.131

- Added options “Enable Video FEC”, “Video FEC Mode”, and “FEC Payload Type. [Account/Codec Settings]
- Added option “Enable MPK Auto Arrangement”.
- Added support IPv6 on GXV32xx. [Maintenance/Network Settings]
- Added ability to configure the provisioning/firmware URL with variable. [Maintenance/Upgrade]
- Added ability to configure timeout on phone LCD for on-hook dialing. [Advanced Settings/Call Features]
- Added option “Enable CDP”. [Maintenance/Network Settings]
- Added options “GUI Customization File Download Mode”, “GUI Customization File URL”, “GUI Customization File HTTP/HTTPS Username”, “GUI Customization File HTTP/HTTPS Password”, and “Use Configuration of Config File Server”. [Maintenance/Upgrade]
- Added option “Disable Web GUI”. [Maintenance/Web/SSH Access]
- Added an option to mute the touch screen clicks only. [Sound]
- Added ability for “Users” to check/edit the MPK Extension when connected with user privilege.
- Added “Different Networks for Data and VoIP Calls” option. [Maintenance/Network Settings]
- Adjusted the RX/TX options for headsets. Added the RX/TX gain options for Virtual Sound Card. [Maintenance/Device Manager]
- Added support for RFC3605.
- Added the ability to connect to the nearest Wi-Fi Access Point.
- Added validation check for Multicast Address.
- Added “Dial DTMF Button Size” and “Dial DTMF Button Color” options. [Advanced Settings/Call Features]
- Added options “Show Dial DTMF Softkey” and “CID to Show Dial DTMF Softkey”. [Account/Call Settings]
- Added support for DHCP Option 132 and 133 tunneled through DHCP Option 43. [Maintenance/Network Settings]
- Added “Attended Conference”, “Use 3rd Party App as Basic Phone”, and “Auto UnHold When Press the Line Key” options. [Advanced Settings/Call Features]



Firmware Version 1.0.3.92

- Changed default config file update method to HTTPS for security purpose. [Maintenance/Upgrade]
- Added H.263 support and RTCP packets loss tolerance. [Account/Codec Settings]
- Added option “Use First Matching Vocoder in 200OK SDP”. [Account/Codec Settings]
- Added option “Authentication Type” for Broadsoft XSI feature. [Maintenance/Broadsoft Directories]
- Added IEEE-48-addr and IEEE-EUI-64 support in PEI (P-Emergency-Info) header.

Firmware Version 1.0.3.75

- Add Codec Negotiation Priority. [Account/Codec Settings]
- Add Video Display Mode. [Advanced Settings/Video Settings]
- Add Phonebook Key Function. [Maintenance/Contacts]
- Add Firmware HTTP/HTTPS User Name. [Maintenance/Upgrade]
- Add Firmware HTTP/HTTPS Password. [Maintenance/Upgrade]
- Update the “Upgrade” configuration options, “Firmware Upgrade Via” and “Config Via” have been separate to two options. [Maintenance/Upgrade]

Firmware Version 1.0.3.62

- Add Configure Door System. [Account/Call Settings]
- Add Disable Video Call Feature. [Advanced Settings/Call Features]

Firmware Version 1.0.3.55

- Add Use H.264 Constrained Profiles. [Account/Codec Settings]
- Add HTTP/HTTPS User-Agent. [Maintenance/Network Settings]
- Add SIP User-Agent. [Maintenance/Network Settings]
- Add Allow DHCP Option 242 (Avaya IP Phones). [Maintenance/Upgrade]
- Add Authentication Type. [Maintenance/Broadsoft Directories]

Firmware Version 1.0.3.46

- Add RTP IP Filter. [Account/SIP Settings]

Firmware Version 1.0.3.37

- Add Allow Unsolicited REFER. [Account/SIP Settings]
- Add Allow SIP Reset. [Account/SIP Settings]
- Add Opus Payload Type. [Account/Codec Settings]
- Add Trusted CA Certificates. [Advanced Settings/General Settings]
- Add Import Trusted CA Certificates. [Advanced Settings/General Settings]
- Add Enable DHCP VLAN. [Maintenance/Network Settings]
- Add Layer 2 QoS 802.1Q/VLAN Tag (Wi-Fi). [Maintenance/Network Settings]
- Add Layer 2 QoS 802.1p Priority Value (Wi-Fi). [Maintenance/Network Settings]



- Add Upload Device Configuration. [Maintenance/Upgrade]

Firmware Version 1.0.3.30

- Add Re-register before Expiration. [Account/SIP Settings]
- Add Enable SIP OPTIONS Keep Alive. [Account/SIP Settings]
- Add SIP OPTIONS Keep Alive Interval. [Account/SIP Settings]
- Add OPTIONS Keep Alive Maximum Tries. [Account/SIP Settings]
- Add Validate Certification Chain. [Account/SIP Settings]
- Update Domain Certificate to Trusted CA Certificates. [Account/SIP Settings]
- Add G726-32 ITU Payload. [Account/Codec Settings]
- Add G726-32 Dynamic PT. [Account/Codec Settings]
- Add Packetization Mode. [Account/Codec Settings]
- Add Enable SRTP Key Life Time. [Account/Codec Settings]
- Add Disable Presentation. [Account/Call Settings]
- Add Don't Prompt Missed Call under Call Log. [Account/Call Settings]
- Add NEC / WorldStone / Baudisch Door System under Special Feature. [Account/Call Settings]
- Add Enable BroadSoft Call Park. [Account/Call Settings]
- Add Multicast Paging under Programmable Keys. [Account/Call Settings]
- Add SIP Domain. [Advanced Settings/General Settings]
- Add Call Forward under Enable Function for Incoming Call. [Advanced Settings/Call Features]
- Update Dialer Interface Priority to Always Display Dialer Interface. [Advanced Settings/Call Features]
- Add Desktop Menu as Hook Dial. [Advanced Settings/Call Features]
- Add Call Function Buttons. [Advanced Settings/Call Features]
- Add Auto Config CPT by Region. [Advanced Settings/Tone Generator]
- Add Force BLF Call-pickup by Prefix.
- Add Show IP Address on Account Widget. [Maintenance/Network Settings]
- Add 802.1x Secret under EAP-MD5 and EAP-PEAP. [Maintenance/Network Settings]
- Add Validate Server Certificate. [Maintenance/Upgrade]
- Add Disable SIP NOTIFY Authentication. [Maintenance/Upgrade]
- Add Send SIP Log. [Maintenance/Syslog]
- Add EVENT NOTIFY. [Maintenance/Event Notif]
- Add HTTP/HTTPS User Name for downloading phonebook file. [Maintenance/Contacts]
- Add HTTP/HTTPS Password for downloading phonebook file. [Maintenance/Contacts]
- Update BroadSoft Directory Hits option under BroadSoft Directories. [Maintenance/Broadsoft Directories]
- Update BroadSoft Directory Order option under BroadSoft Directories. [Maintenance/Broadsoft Directories]
- Add LDAP Dialing Default Account. [Maintenance/LDAP Book]
- Add BroadSoft Directory User ID. [Maintenance/Broadsoft Directories]
- Add Handset TX Gain. [Maintenance/Device Manager]
- Add Handset RX Gain. [Maintenance/Device Manager]
- Add Handset Equalizer RX. [Maintenance/Device Manager]



Firmware Version 1.0.3.22

- Update Wi-Fi Settings. [Wi-Fi Settings]
- Update Display. [Display]
- Update Status/System Info. [Status/System Info]
- Update General Settings. [Account/General Settings]
- Update Codec Settings. [Account/Codec Settings]
- Update Call Settings. [Account/Call Settings]
- Update Call Features. [Advanced Settings/Call Features]
- Update Tone Generator. [Advanced Settings/Tone Generator]
- Add Multicast Paging. [Advanced Settings/Multicast Paging]
- Update MPK General Settings.
- Update MPK LCD Settings. [Advanced Settings/MPK LCD Settings]
- Update Network Settings. [Maintenance/Network Settings]
- Update WIFI Settings. [Maintenance/Wi-Fi Settings]
- Update Contact Settings. [Maintenance/Contacts]
- Update LDAP Book Settings. [Maintenance/LDAP Book]
- Update BroadSoft Directories. [Maintenance/Broadsoft Directories]
- Add BroadSoft IM&P. [Maintenance/Broadsoft IM&P]
- Update Device Manager Settings. [Maintenance/Device Manager]

Firmware Version 1.0.3.6

- Add Full-screen Video Calling. [Personalized Account]
- Add ICE Contacts. [Maintenance/Contacts]
- Add Session Expiration. [Account/SIP Settings]
- Add Caller ID display. [Account/SIP Settings]
- Add SIP timer D interval. [Account/SIP Settings]
- Add Check Domain Certificate. [Account/SIP Settings]
- Add Disable DialPlan. [Account/Call Settings]
- Add Multiply Server Mode Group. [Account/Call Settings]
- Add DND Call Feature On. [Account/Call Settings]
- Add DND Call Feature Off. [Account/Call Settings]
- Add Programmable keys. [Account/Call Settings]
- Add Display Soft Keyboard. [Advanced Settings/Call Features]
- Add BS Contacts Hits. [Maintenance/Broadsoft]
- Add BS Contacts Order. [Maintenance/Broadsoft]
- Delete Handset TX Gain (dB). [Maintenance/Device Manager]
- Delete Handset RX Gain (dB). [Maintenance/Device Manager]

Firmware Version 1.0.1.54

- Add Hide LDAP Contacts.



- Add Hide Local Call History.
- Add BS Call Log Update Interval.
- Add SRTP Encryption Bit.
- Add BroadWorks Xsi features.
- Add Enable Function for Incoming Call.

Firmware Version 1.0.1.39

- Add Check SIP User ID for Incoming INVITE setting.
- Add Only Accept SIP Requests from Known Servers setting.
- Add Configuration via Keypad Menu setting.
- Delete Configuration via LCD Menu setting.

Firmware Version 1.0.1.29

- This is the initial version.



WELCOME

Thank you for purchasing Grandstream GXV3240 Enterprise Multimedia Phone for Android™. The GXV3240 combines a 6-line IP video phone with the power of a multi-platform video conferencing solution and the convenience of an Android smartphone to offer an all-in-one voice, video, data, and mobility solution. The GXV3240 is a 6-line IP multimedia phone with a 4.3" capacitive touch screen that runs the Android Operating System and therefore offers full access to the hundreds of thousands of Android apps in the Google Play Store - including business productivity apps such as Skype™, Microsoft Lync™, Salesforce1™, and GoToMeeting™. The phone features Gigabit ports, HD audio and HD video, a built-in web browser, integrated Wi-Fi for network flexibility, PoE, and a tilt able CMOS camera. The GXV3240 is compatible with the GXP2200 Extension Module, allowing quick and easy access to up to 160 contacts at the touch of a finger. The GXV3240's integrated Bluetooth allows users to sync the calendar and contact books on their mobile phones with the GXV3240, to use Bluetooth headsets, and to transfer calls to and from the phone to their mobile phones. By combining a state-of-the-art IP phone, an advanced video conferencing solution, and the Android operating system, businesses throughout the world can now use one IP Phone for all communication and productivity needs.



PRODUCT OVERVIEW

Feature Highlights

The following table contains the major features of the GXV3240:

Table 1: GXV3240 Features in a Glance

 <p>GXV3240</p>	<ul style="list-style-type: none"> • 6 lines with up to 6 SIP accounts including FREE IPVideoTalk account with video mail, up to 6-way audio conference and 3-way video conference, phonebook with up to 1000 contacts, call history with up to 1000 records • Dual switched auto-sensing 10/100/1000Mbps network ports, Wi-Fi (802.11b/g/n), PoE+, Bluetooth with BlueBorne vulnerability, USB, SD, HDMI, EHS with Plantronics headsets support • 4.3" (1024x600) capacitive (5 points) touch screen TFT LCD, megapixel CMOS sensor camera with privacy shutter • HD wideband audio, full-duplex hands-free speakerphone with advanced acoustic echo cancellation • Runs the Android™ Operating System 4.2 and offers full access to the Google Play Store - which includes thousands of business productivity apps such as Skype, Microsoft Lync, Salesforce1, GoToMeeting • Integrate with Grandstream's GXV series of IP video surveillance cameras to view live camera feeds and to receive alerts/alarms from IP cameras installed on the same network • Offers a multi-platform video conferencing solution (Grandstream's Free IPVideoTalk, Skype, Microsoft Lync, and more) • Create Android applications for any business need to run on GXV3240 using Google's API and Grandstream's SDK toolkit
---	---

GXV3240 Technical Specifications

The following table resumes all the technical specifications including the protocols / standards supported, voice codecs, telephony features, languages and upgrade/provisioning settings for the phone GXV3240.

Table 2: GXV3240 Technical Specifications

Protocols/Standards	SIP RFC3261, TCP/IP/UDP, RTP/RTCP, HTTP/HTTPS, ARP, ICMP, DNS (A record, SRV, NAPTR), DHCP, PPPoE, SSH, TFTP, NTP, STUN, SIMPLE, LLDP-MED, LDAP, TR-069, 802.1x, TLSv1.1, TLSv1.2, SRTP, RFC3605.
Network Interfaces	Dual switched 10/100/1000 Mbps ports with integrated PoE
Graphic Display	4.3"(480*272) capacitive (5 points) touch screen TFT LCD
Camera	Tiltable mega pixel CMOS camera privacy shutter
Bluetooth	Yes, integrated. Bluetooth 4.0 + EDR, BlueBorne vulnerability.
Wi-Fi	Yes, integrated. 802.11b/g/n
Auxiliary Ports	RJ9 headset jack (allowing EHS with Plantronics headsets), 3.5mm stereo headset with microphone, dual USB ports, SD, mini HDMI
Feature Keys	11 function keys for PHONEBOOK, BACKSPACE, HEADSET, MUTE, HOLD, MESSAGE, TRANSFER, CONFERENCE, SPEAKERPHONE, SEND/REDIAL, VOLUME. 3 dedicated Android keys for HOME, MENU, and BACK
Voice Codec	Support for G.711 μ /a, G.722 (wide-band), G.726-32, G.729, iLBC, OPUS, in-band and out-of-band DTMF (In audio, RFC2833, SIP INFO)
Video Codec and Capabilities	H.264 BP/MP/HP, H263, video resolution up to 720p HD, frame rate up to 30 fps, bit rate up to 2Mbps, 3-way video conference, anti-flickering, auto focus and auto exposure, PIP (Picture-in-Picture), on-screen-display, camera block, still picture capture/store, video recording, visual voice message indicator
Telephony Features	Hold, transfer, forward (unconditional/no-answer/busy), call park/pickup, 6-way audio conference, shared-call-appearance (SCA) / bridged-line-appearance (BLA), virtual MPK, downloadable phone book (XML, LDAP), call waiting, call history, boss-secretary virtual button, flexible dial plan, Hot Desking, personalized music ringtones, server redundancy & fail-over
Sample Applications	Skype, Google Hangouts, Microsoft Lync, Web browser, GoToMeeting, Facebook, Twitter, YouTube, news, weather, stock, Internet Radio, Pandora, Last.fm, Yahoo Flickr, Photo bucket, alarm clock, Google calendar, mobile phone data import/export via Bluetooth, etc. API/SDK available for advanced custom application development
Applications Deployment	Allow various Android operating system 4.2 compliant applications to be developed, downloaded and run in the embedded device with provisioning control
HD Audio	Yes, both handset and speakerphone support HD (wide-band) audio
Base Stand	Yes, integrated stand with multiple adjustable angles. Wall mountable
QoS	Layer 2 QoS (802.1Q, 802.1p) and Layer 3 (ToS, DiffServ, MPLS) QoS



Security	User and administrator level access control, MD5 and MD5-sess based authentication, 256-bit AES encrypted configuration file, TLS, SRTP, HTTPS, 802.1x media access control
Multi-language	English, German, Italian, French, Spanish, Portuguese, Russian, Croatian, Dutch, Chinese, Korean, Japanese, and more
Upgrade/ Provisioning	Firmware upgrade via TFTP / HTTP / HTTPS or local HTTP upload, mass provisioning using TR-069 or AES encrypted XML configuration file
Power and Green Energy Efficiency	Universal power adapter included: Input: 100-240VAC 50-60Hz; Output: 12VDC, 1.5A (18W); Integrated PoE+ (Power-over-Ethernet) 802.3at, Class 4
Physical	Dimension : 196.5mm (W) x 206.2mm (L) x 85.2mm (H) Unit weight: 0.92kg Package weight: 1.45kg
Temperature and Humidity	Operating: 0°C to 40°C Storage: -10°C to 60°C Humidity: 10% to 90% Non-condensing
Package Content	GXV3240 phone, handset with cord, base stand, universal power supply, network cable, lens cleaning cloth, quick installation guide, brochure, GPL license
Compliance	FCC : Part 15 (CFR47) Class B, Part15C, MPE, UL 60950 (Power Adapter) CE : EN55022 Class B, EN55024 Class B, EN61000-3-2, EN61000-3-3, EN60950-1, EN300-328, EN301-489, EN62311, EN62479, RoHS RCM: AS/ACIF S004, AS/NZS CISPR22/24 Class B, AS/NZS 60950, AS/NZS 4268, AS/NZS 4771

GETTING STARTED

This chapter provides basic installation instructions including the list of the packaging contents and also information for obtaining the best performance with the GXV3240.

Equipment Packaging

Table 3: Equipment Packaging

GXV3240
<ul style="list-style-type: none"> • 1 x GXV3240 Main Case. • 1 x Handset. • 1 x Phone Card. • 1 x Ethernet Cable. • 1 x 12V Power Adapter. • 1 x Wall Mount. • 1 x Phone Stand. • 1 x Screen Cleaning Cloth • 1 x Quick Installation Guide. • 1 x GPL License.

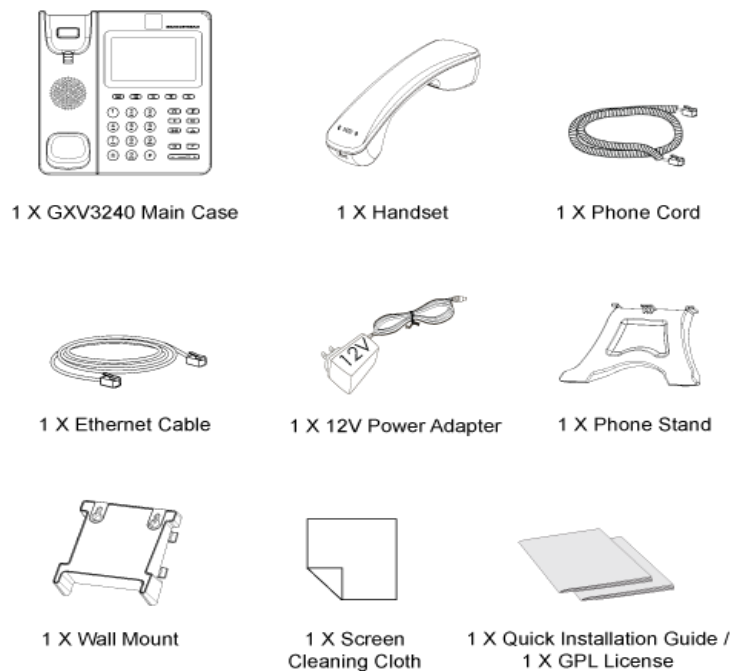

Figure 1: GXV3240 Package Content

Note: Check the package before installation. If you find anything missing, contact your system administrator.

GXV3240 Phone Setup

The GXV3240 can be installed on the desktop using the built-in stand or attached on the wall using the slots for wall mounting.

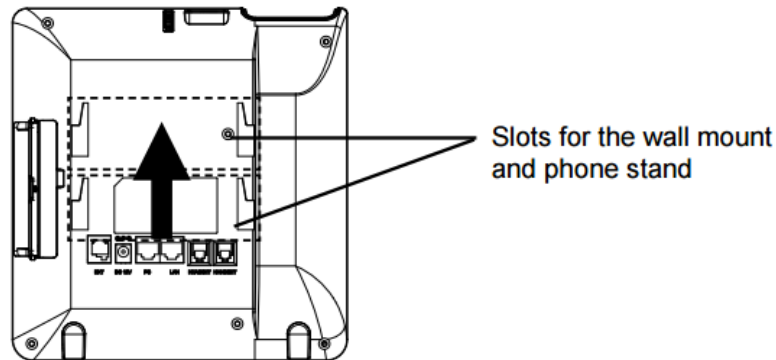

Figure 2: Slots for the Wall Mount and Phone Stand on the GXV3240.

Using the Phone Stand

The GXV3240 has a built-in phone stand. To set up the GXV3240 as your desk phone, follow the steps below:

1. Attach the phone stand to the back of the phone where there is a slot for the phone stand. Upper part and bottom part are available for two angles;
2. Connect the handset and main phone case with the phone cord;

Using the Slots for Wall Mounting

1. Attach the wall mount to the slots on the back of the phone;
2. Attach the phone to the wall via the wall mount hole;
3. Pull out the tab from the handset cradle (see figure below);
4. Rotate the tab and plug it back into the slot with the extension up to hold the handset while the phone is mounted on the wall.

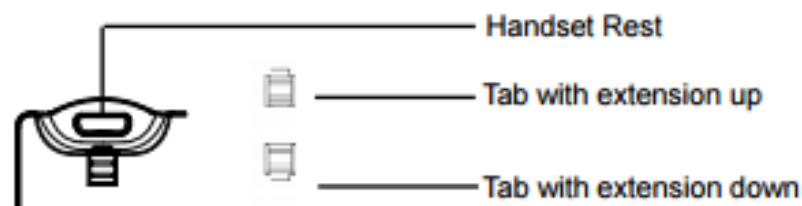

Figure 3: Tab on the Handset Cradle

Connecting the GXV3240

To setup your GXV3240, please follow the steps below:

1. Connect the handset and main phone case with the phone cord;
2. Connect the LAN port of the phone to the RJ-45 socket of a hub/switch or a router (LAN side of the router) using the Ethernet cable;
3. Connect the 12V DC output plug to the power jack on the phone; plug the power adapter into an electrical outlet. If PoE switch is used in step 2, this step could be skipped;
4. The LCD will display booting up or firmware upgrading information. Before continuing, please wait for the main screen display to show up;
5. Using the web configuration interface or from the menu of the touch screen, you can further configure network connection using static IP, DHCP and etc.

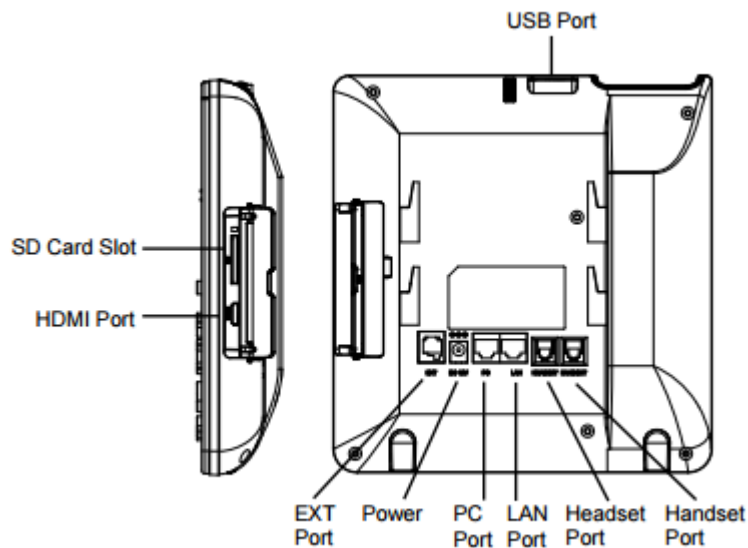

Figure 4: GXV3240 Back View

GXV3240 LCD SETTINGS

The GXV3240 LCD Menu provides an easy access to the settings on the phone. Some of the settings from Web GUI could be configured via the LCD as well. The following table shows the LCD setting menu options.

Table 4: GXV3240 LCD Settings

Personalized Account	<ul style="list-style-type: none"> • Ringtone • Auto-Answer • Shared call appearance (SCA) • Call forwarding • Full-screen video calling ON/OFF
Wireless & Network	<ul style="list-style-type: none"> • Ethernet settings • Wi-Fi ON/OFF • Wi-Fi settings • Bluetooth ON/OFF • Bluetooth settings (available when Bluetooth is turned on) • VPN • Proxy settings • Additional network settings • Tethering & portable hotspot
Sound	<ul style="list-style-type: none"> • General • Silent mode ON/OFF • HDMI ON/OFF • Line Order • Volumes • Incoming Calls • Ringtone • Notifications • Notification tone
Display	<ul style="list-style-type: none"> • Brightness • Screen timeout • Screensaver timeout • Daydream • Font size • Landscape screen • HDMI control
Storage	<ul style="list-style-type: none"> • Display storage status for internal storage, SD card and USB flash drive devices plugged into the phone
Applications	<ul style="list-style-type: none"> • Manage applications installed on the phone
Location Access	<ul style="list-style-type: none"> • Access to my location ON/OFF • Wi-Fi & mobile network location



Security Settings	<ul style="list-style-type: none"> • Screen security • Screen Lock • Owner info • Passwords • Make passwords visible • Device administration • Device administrators • Unknown sources • Verify apps • Credential storage • Trusted credentials • Install from SD card • Clear credentials
Language & Keyboard	<ul style="list-style-type: none"> • Language • Spell checker • Personal dictionary • Keyboard & input methods • Default • Speech • Text-to-speech output • Mouse/Track pad • Pointer speed
Accounts	<ul style="list-style-type: none"> • Add account to the phone to sync up contacts and Google Calendar, sign in Google Play (if installed), sign in Email and etc
Date & Time	<ul style="list-style-type: none"> • Enable and use specified NTP server address • Set date • Set time • Set time zone • Use 24-hour format • Choose date format
About Phone	<ul style="list-style-type: none"> • Display phone's status. No configuration is necessary here • Account status • Network status • System info
Advanced Settings	<ul style="list-style-type: none"> • Account. Configure SIP account registration information • Upgrade • Syslog • Factory Reset • Developer mode
Reboot	<ul style="list-style-type: none"> • Reboot the phone



Open LCD Settings

To open the settings menu, you should:

- Access to the LCD screen menu and then tap on **Settings**;
- Or
- On GXV3240 idle screen, press MENU button  and then tap on **System settings**.

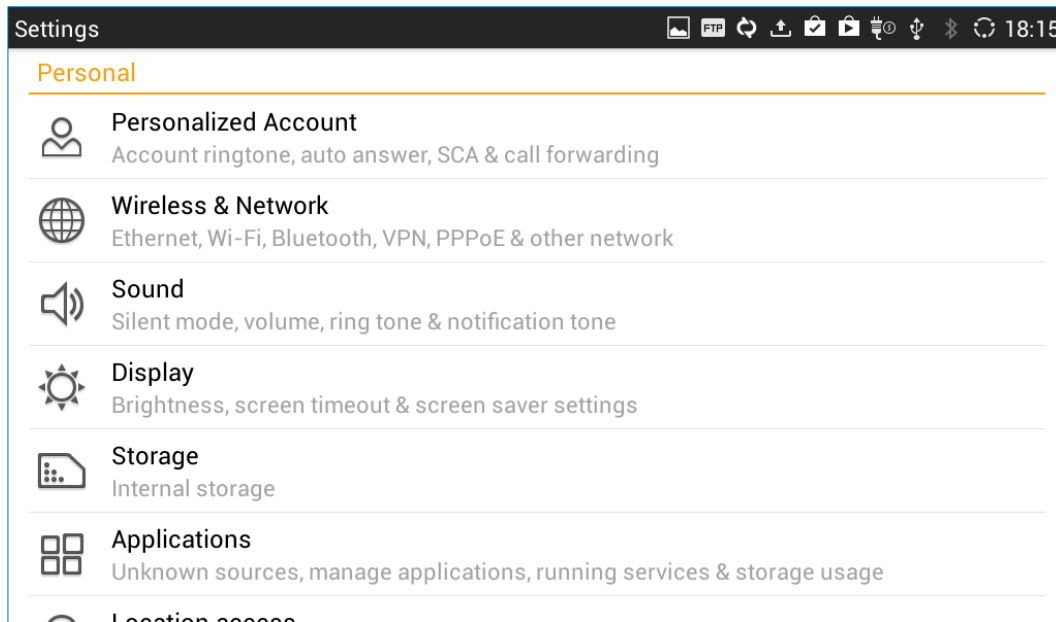

Figure 5: GXV3240 System Settings

Personalized Account

In this menu, all the six SIP accounts will show up with registration status displayed. Tap to select the SIP account to configure ring tone, auto answer, shared call appearance and call forwarding settings.

- **Ringtone**
 Select ring tone for the incoming call to this SIP account. If "Custom Ringtone" is selected, File Manager will be opened for users to choose their own music file to be configured as the incoming call ring tone. Users will see the music file name as the ring tone name in account ring tone settings in LCD as well as in web GUI.
- **Auto-Answer**
 - If set to "Always", the phone will automatically turn on the speaker phone to answer all incoming calls.
 - If set to "Enable Intercom/Paging", the phone will answer the call based on the SIP info header sent from the server/proxy.
 - By default, it's turned off.

- **Shared Call Appearance (SCA)**

- **Shared Call Appearance (SCA):** Enable or disable SCA on the account.
- **Enable Barge-in:** If set to "Yes", the user could barge into an active call on a shared line.
- **Auto Fill Call Park Code:** If set to "Yes", the configured "Call Park Service Code" will be automatically filled in on the phone's dial pad when picking up the parked call. This is used when "Special Mode" is set to "BroadSoft" (from web UI or provisioning) and "Enable SCA" is set to "Yes".
- **Call Park Service Code:** Configure the retrieving feature code for call parking. If "Auto Fill Call Park Code" is set to "Yes", this call park service code will be automatically filled in on the phone's dial pad when picking up the parked call. This is used when "Special Mode" is set to "BroadSoft" (from web UI or provisioning) and "Enable SCA" is set to "Yes".
- **Seize Line Timeout (s):** Configure the time for the line can be seized (in seconds) when using shared line. The default setting is 15 seconds. For Shared Call Appearance, phone will send a SUBSCRIBE-request for the line-seize event package whenever a user attempts to take the shared line off hook. "Line Seize Timeout" is the line-seize event expiration timer.

- **Call Forwarding**

The incoming call to this SIP account can be forwarded to another account using different rules as configured here.

- **None:** Call forwarding feature is disabled. This is the default setting.
- **Unconditional:** Forward all calls to a particular number.
- **Time based:** Set the time range and number to be forwarded to. In this time range, calls are forwarded to the number specified in "**In Time Forward To**"; out of this time range, calls are forwarded to the number specified in "**Out Time Forward To**".
- **Others:** When the phone is busy, calls are forwarded to the number specified in "**Busy To**"; when incoming calls are not answered, the calls are forwarded to the number specified in "**No Answer To**"; the waiting time for answering calls is specified in "**No Answer Timeout (s)**". Finally, when the phone is set on DND mode the call will be forwarded to the number configured under the field "**DND To**".

- **Full screen video calling**

Set to automatically enable the full screen video call mode for inbound and outbound video calls.

Wireless & Network

Users can configure Ethernet settings, Wi-Fi, Bluetooth, VPN, PPPoE and other advanced network settings here.









Ethernet Settings

Configure DHCP, Static IP or PPPoE for the phone to access network via Ethernet settings.

- If **DHCP** is selected, the phone will get an IP address automatically from the DHCP server in the network. This is the default mode.
- If **Static IP** is selected, manually enter the information for IP Address, Subnet Mask, Default Gateway, DNS Server and Alternative DNS server.
- If **PPPoE** is selected, type PPPoE Account ID and PPPoE Password provided from the PPPoE server to get authenticated for network access.

Wi-Fi Settings

- Tap on "**Wi-Fi**" to turn on/off Wi-Fi connection. By default, it's turned off.
- Tap on "**Wi-Fi Settings**" to set up and manage wireless access points. This option is available only when Wi-Fi is turned on.
 - **WPS Push Button.** Press MENU button  and select "WPS Push Button" for an easy and secure Wi-Fi network setup. Once selected, check your router and press the Wi-Fi Protected Setup (WPS) button on the router so that the Wi-Fi connection and security can be automatically set up between the phone and the router. The phone should get network connection shortly after successfully setup.
 - **Add Network.** If the Wi-Fi network SSID doesn't show up in the list, or users would like to set up advanced options for the Wi-Fi network, press MENU button  and select "Add Network". Then Enter SSID, Security type, password and set up address type (DHCP/Static IP/PPPoE) in the prompt dialog. The phone will reboot with Wi-Fi network connected.
 - **Scan.** Press MENU button  and select "Scan" to initiate scan for the Wi-Fi network within the range.
 - **WPS PIN Entry.** Press MENU button  and select "WPS PIN Entry" for an easy and secure Wi-Fi network setup. Once selected, a randomly generated PIN number will show on the phone for you to enter it on your Wi-Fi router. The setup can take up to 2 minutes to complete and the phone should get network connection once done.
 - **Wi-Fi Direct.** This is to set up peer-to-peer connection between two Wi-Fi Direct devices so that they can share data and sync files. Press MENU button  button and select "Search for devices". Then tap on the available peer device to initiate connection.
 - **Advanced Settings.** Press MENU button  and select "Advanced".
 - **Network notification:** If enabled, the phone will show notification on the top status bar indicating an open network is available. By default it's enabled.
 - **Avoid poor connections:** If enabled, Wi-Fi network won't be used unless the connection is good. By default it's disabled.
 - **MAC address:** This shows the MAC address of the phone.
 - **IP address:** This shows the IP address of the phone from Wi-Fi network.



For more information about how to use Wi-Fi on the GXV3240, please refer to the following link:

http://www.grandstream.com/sites/default/files/Resources/gxv3240_wifi_guide_0.pdf

Bluetooth Settings

- Tap on "**Bluetooth**" to turn on/off Bluetooth connection. By default, it's turned off.
- Tap on "**Bluetooth Settings**" to set up and manage Bluetooth connections. This option is available only when Bluetooth is turned on.

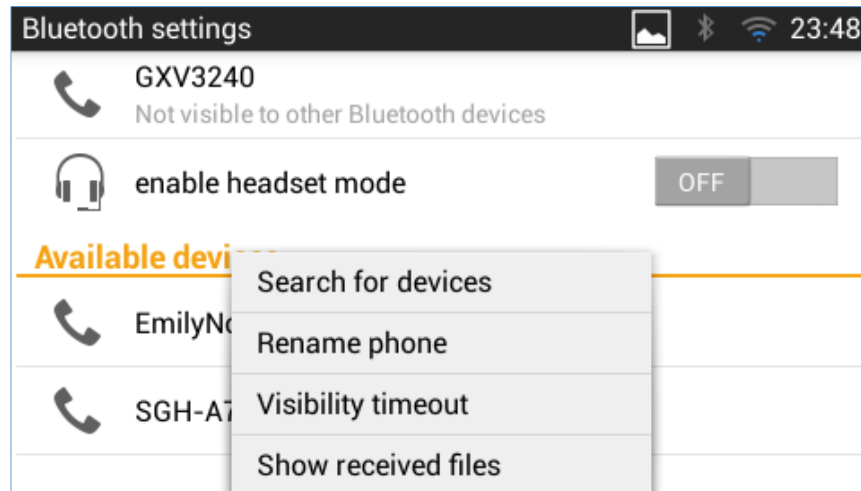







Figure 6: GXV3240 Bluetooth Settings

- **Visibility.** Tap on "**GXV3240**" on the top of the above screen to switch visibility status of the phone via Bluetooth. Normally you would need to turn it on during pairing process so that other Bluetooth devices can discover the GXV3240.
- **Visibility timeout.** Press MENU button  and select "Visibility timeout". Tap to select the timeout interval among "2 minutes", "5 minutes", "1 hour" or "never". By default, the visibility timeout is 2 minutes.
- **Rename phone.** Press MENU button  and select "Rename phone" to change the name of the GXV3240, which is displayed on other Bluetooth devices when discovered. By default, it's "**GXV3240**" as shown on the top of the Bluetooth settings screen.
- **Search for devices.** Press MENU button  and select "Search for devices" to initiate scan process on the GXV3240 to discover the Bluetooth devices within the range.
- **Enable headset mode.** When it's turned on, the connected mobile devices via Bluetooth can switch phone call to the GXV3240 so that users can talk using the GXV3240 handset/speaker for phone calls on the mobile devices. The Bluetooth Handsfree profile for the mobile phone number will also show as one line in the dial screen for users to make call using the GXV3240.
- **Pairing.** Tap on the Bluetooth device name in the scan result to pair and connect to the device.

- **Show received files.** Press MENU button  and select "Show received files" to view Bluetooth file transfer history and access received files.
- **Paired device settings.** If the device is paired, tap on icon  on the right side of the paired Bluetooth device name to access settings including "Rename", "Unpair" and "Headset audio". Please note "Headset audio" can be turned on only if "Enable headset mode" is set to Yes.

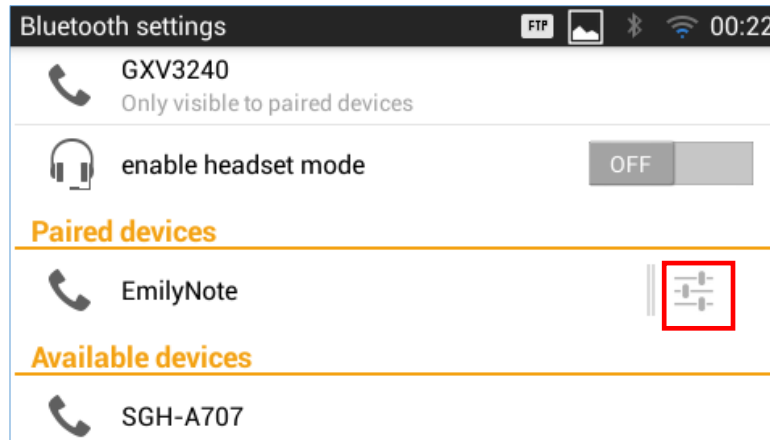

Figure 7: GXV3240 Bluetooth Paired Device Settings

For more information about Bluetooth feature on the GXV3240, please refer to the following link:
http://www.grandstream.com/sites/default/files/Resources/gxv3240_bluetooth_guide_1.pdf

VPN

1. Tap on "Add VPN profile" to set up VPN connection.
 The supported VPN type are "PPTP", "L2TP/IPSec PSK", "L2TP/IPSec RSA", "IPSec Xauth PSK", "IPSec Xauth RSA" and "IPSec Hybrid RSA".
2. Once added, the profile will be displayed in the VPN list.
3. Touch and press it for about 2 seconds until a dialog box shows up. Users can select to edit this VPN profile or delete it.

Proxy Settings

For some network setup, it is required to connect to the Internet via proxy server. Manually configure "Proxy hostname", "Proxy port" and "Bypass proxy for" in proxy settings for the phone to get Internet connection successfully.

Additional Network Settings

- **LLDP**
 Turn on/off LLDP on the GXV3240. If turned on, the phone will be able to discover the LAN polices as set up in the switch side to obtain network settings such as VLAN tag, Layer 2 QoS 802.1p priority and Layer 3 QoS in a plug-and-play manner.



- **Layer 3 QoS for SIP**
This field defines the layer 3 QoS parameter for SIP packets. This is the value used for IP Precedence, Diff-Serv or MPLS. The Default value is 48.
- **Layer 3 QoS for Audio**
This field defines the layer 3 QoS parameter for audio packets. This is the value used for IP Precedence, Diff-Serv or MPLS. The Default value is 48.
- **Layer 3 QoS for Video**
This field defines the layer 3 QoS parameter for video packets. This is the value used for IP Precedence, Diff-Serv or MPLS. The Default value is 48.
- **Layer 2 QoS 802.1Q/VLAN Tag**
This field contains the value used for layer 2 VLAN tagging. The Default value is 0.
- **Layer 2 QoS 802.1p/Priority Value**
This assigns the priority value of the Layer2 QoS packets. The Default value is 0.
- **802.1x mode**
This option allows the user to enable/disable 802.1x mode on the phone. The default setting is disabled. To enable 802.1x mode, select the 802.1x mode, enter the Identity and MD5 Password to be authenticated to the network.
- **802.1x Identity**
This field is for inputting the identity information for the 802.1x EAP-MD5 mode.
- **802.1xPassword**
This field is for inputting the password for the 802.1x EAP-MD5 mode.

Tethering & Portable Hotspot

The GXV3240 can be served as a Wi-Fi access point for other devices to connect to wireless network if hotspot is turned on.

1. Turn on hotspot by tapping on "Portable Wi-Fi hotspot". Icon  will show on the top status bar of the GXV3240.
2. Tap on "Set up Wi-Fi hotspot" to configure network SSID, security type and password. Please make sure the password has at least 8 characters. Otherwise, users won't be able to save the setting.
3. On the other device that needs Wi-Fi access, turn on Wi-Fi, look for the SSID of the GXV3240 hotspot and enter authentication information to get connected.



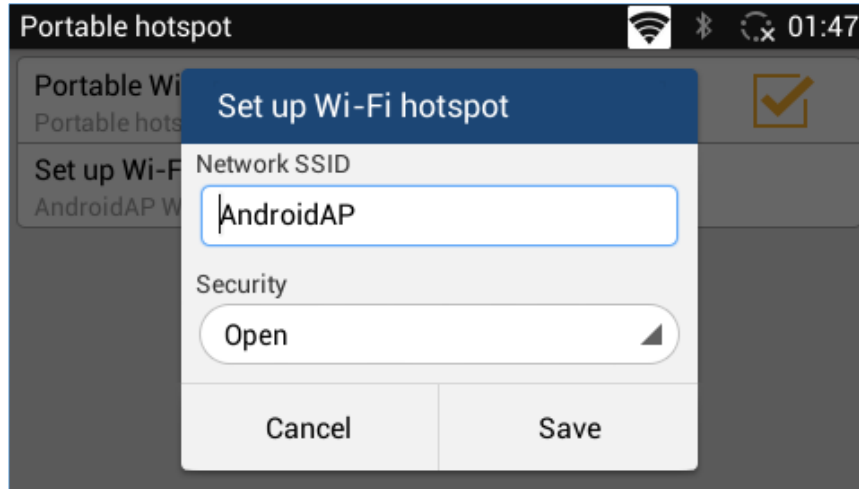



Figure 8: GXV3240 Wi-Fi Hotspot

Sound



Use the Sound settings to configure phone's sound mode, volume, ring tone and notification tone.

- **Silent mode.** Tap on it to turn on/off the sound from speaker when there is an incoming call.
- **Touch Sounds.** Tap on it to turn on/off the touch screen sound.
- **HDMI.** Tap on it to switch the audio output between the HDMI and local channels when HDMI device connected. If it is on, the audio will be output via the remote HDMI device. Or it will output from local speaker, headset or other non-HDMI audio channels.
- **Line order.** Tap on it to select 3.5mm earphone line order "CTIA" or "OMTP". Audio loopback test for the selected option is available if the 3.5mm earphone is plugged in.
- **Volume.** Tap on **Volume** and scroll left/right to adjust the volume for Ringtone, Media and Alarm. When adjusting the volume, the tone will be played reflecting the volume change.
- **Ringtone.** Select phone's ringtone for incoming call.
- **Notification tone.** Select notification ringtone.

Display

- **Brightness.** Tap on **Brightness** and scroll left/right to adjust the LCD brightness.
- **Screen timeout.** Tap to open the dialog to set the screen timeout interval.
- **Screensaver timeout.** Tap to open the dialog to set the screensaver timeout interval.
- **Daydream.** Tap to select the screensaver on the phone.
 - **Screensaver.** After selecting "Screensaver", tap on  to configure network image path, local image path and animation intervals for screen saver display.
 - **Clock.** Display analog clock as screen saver.
 - **Colors.** Display color as screen saver.



- **Photo Frame.** After selecting "Photo Frame", tap on  to select local pictures to be displayed in photo frame as screen saver.
- **Photo Table.** After selecting "Photo Table", tap on  to select local pictures to be displayed in photo table as screen saver.
- **Font size.** Tap on it to adjust the font size for LCD screen.
- **Landscape screen.** Tap on the checkbox to enable/disable landscape display on all the screens. This option is usually used when the 3rd party application displays vertically when running on the GXV3240 screen. If it is enabled, it may cause some apps disabled.
- **HDMI control.** Tap on it to enable and select HDMI output content when HDMI device connected. If "Close HDMI output" is selected, the HDMI output feature will be turned off. If "HDMI display synchronization with LCD" is selected, the pictures displayed on the remote HDMI device will always be same as the local LCD display. If "Show remote screen" is selected, the remote HDMI device will display the same picture with the phone's LCD screen unless displaying the remote side's video in full size mode during a video call.

Storage

The storage status for phone's internal and external storage devices is sorted and displayed with different categories. Users can tap on the category to manage the corresponding data (see table below).

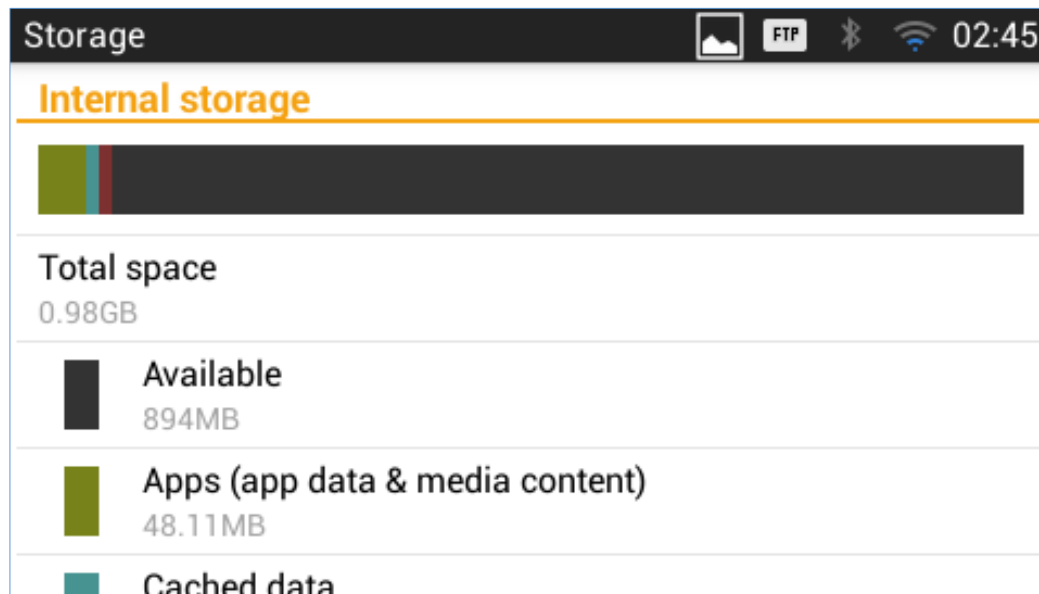

Figure 9: GXV3240 Storage

Table 5: GXV3240 Storage Category and Actions

Apps	Tap on it to access running apps, downloaded apps, all apps and etc. Users could tap on the app to stop the process.
Cached data	Tap on it to clear cached data for all apps.
Misc.	Tap on it to open the file system of the storage in FileManager . Users can then select the folders to be cleaned up.
Picture, videos	Tap on it to open albums in Gallery .
Audio	Tap on it to open the audio file using Music app or FileManager .
Downloads	Tap on it to open download history.

Users can tap on "Erase SD card" to remove all the pictures, videos and files from the SD card in the phone's storage.

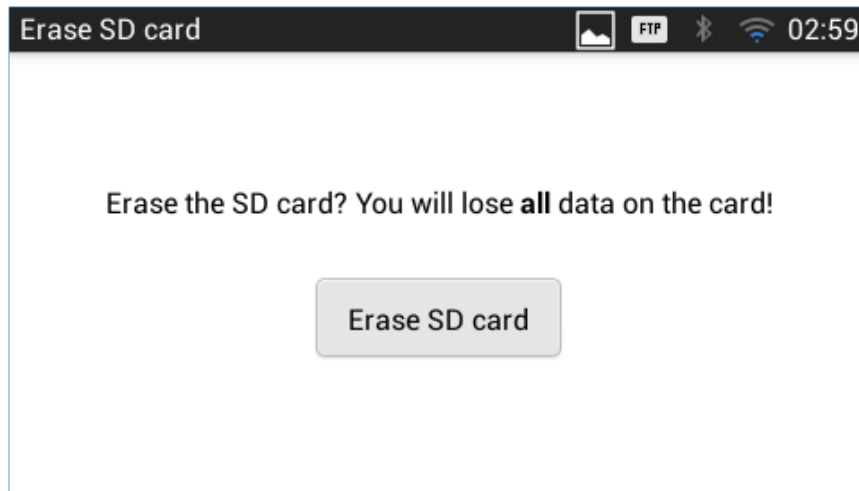

Figure 10: Erase SD Card

Applications

View Applications

Users can view the details and manage the applications installed on the GXV3240. There are four tabs, with lists of applications and their components in each tab. At the bottom of each tab is the memory usage information for the selected tab. The four tabs are:

- **Downloaded:** To view the applications you've downloaded from GS Market or other sources.
- **On SD Card:** To view the applications on the SD card of the phone's storage.
- **Running:** To view running or cached applications.
- **All:** To view all the applications installed on the GXV3240.

User can swipe left/right on the screen to switch among the tabs.



Manage Applications

Tap on an application, process or service to open it. The Application Info screen for each application lists its name, version, size, etc. Depending on the app, it may also include options for managing the application's data, forcing the application to stop, and disabling the application. Usually the options are:

- Tap the "Force stop" softkey to stop an application forcefully. This setting might be valid for some applications.
- Tap the "Stop" softkey to stop an application gracefully. This setting might be valid for some applications.
- Tap the "Disable" softkey to disable the application. Users could tap on "Enable" to turn it back on again. This usually applies to the built-in applications.
- Tap the "Uninstall" softkey to uninstall applications from GS Market or other 3rd party source.
- Storage provides storage information that an application uses on the phone.
- Tap "Clear data" to delete an application setting and other data. This setting might be valid for some applications.
- If the application stores data in a temporary space of the phone's memory, "Cache" lists how much information is stored. Tap on "Clear cache" to clear the cache.
- "Launch by default". If the application is configured to launch certain file type by default, tap on "Clear defaults" to reset this.
- "Permissions" lists information of the data that the app has access to. For example, the application might access the location information, storage, phone calls and etc.
- If an application is misbehaving, tap on "Report" softkey (if available) to send the developer information for the application.



Note:

Stopping a built-in application, operating system processes or services might disable one or more dependent functions on the phone. Users may need to restart the phone to restore full functionality again.

Location Access

- **Access to my location.** Enabling this setting will allow third party apps to send request to access to the location source.
- **Wi-Fi & mobile network location.** Enabling this feature will allow Google's location service to collect anonymous location data.

Security Settings

Screen Security

- **Screen lock.** Set up pattern or password for screen lock. Wizard will be provided to set up the pattern. The screen will be locked after booting up or the screen is off (i.e., screensaver screen activated, or manually slide down **Status Bar**→**System Settings**→**Screen Off**  to turn off LCD).



Users will then be required to enter password or pattern to login. When the screen is locked, users can still be able to answer or reject incoming call.

- **Owner info.** Display owner info on the lock screen. This can be useful if the device is lost.

Passwords

- **Make passwords visible.** Check/uncheck to show/hide letters when user's type screen lock password instantly.

Device Administration

- **Device administrators.** View or deactivate device administrators.
- **Unknown sources.** Check/uncheck to enable/disable permission to install applications that you obtain from web sites, email, or other sources than GS Market and Google Play.
- **Verify apps.** Disable or warn the users before installing the application.

Credential Storage

- **Trusted credentials.** Display trusted CA certificates for system or user. Users can tap on the certificate to check the credential details or disable it.
- **Install from SD card.** Install encrypted certificates from SD card.
- **Clear credentials.** Clear credential storage of all contents and reset its password.

Language & Keyboard

- **Language.** Tap to open a list of language options for the GXV3240 to display with.
- **Spell checker.** Configure whether to check spellings and select the available spell-checker tool.
- **Personal dictionary.** Add new words to user's dictionary so that they won't be displayed as error in the text.
- **Keyboard & input methods.** Set up default input method. The default input method is Android Keyboard.
 - **Default.** Select input method.
 - **Android keyboard.** Set up whether to use Android keyboard or not, and configure Android keyboard including sound, auto-correction, word suggestion and so on.
- **Text-to-speech output.** Set up and configure the text to speech settings.
 - **Prefer engine.** Select the engine type. The default engine is Pico TTS.
 - **Speech rate.** Adjust the speech rate.
 - **Listen to an example.** Play and listen the example of speech synthesis.
- **Pointer speed.** Adjust the sensitivity of the mouse pointer in those devices.



Accounts

The GXV3240 allows users to add Google account, Email account and other 3rd party applications account to the phone. Once the account is associated, the browser, calendar and contacts can be synced up with the signed-in account on the GXV3240.

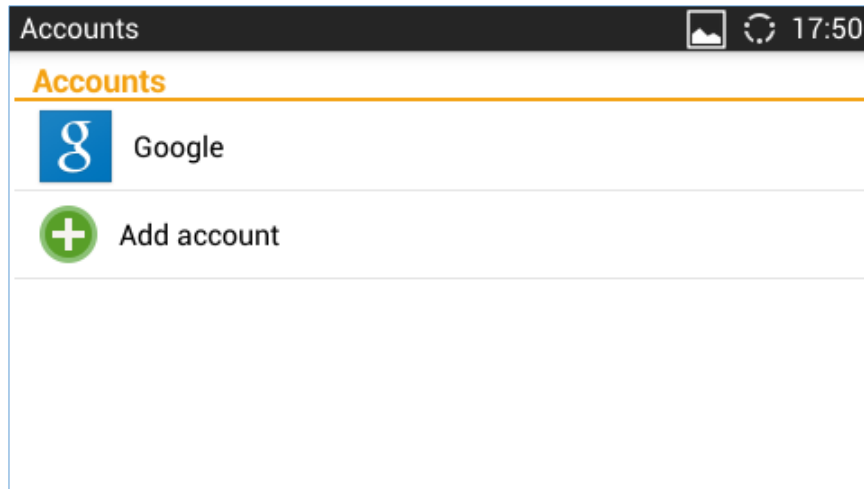

Figure 11: GXV3240 Accounts Sync Up Settings - Google Account Signed In

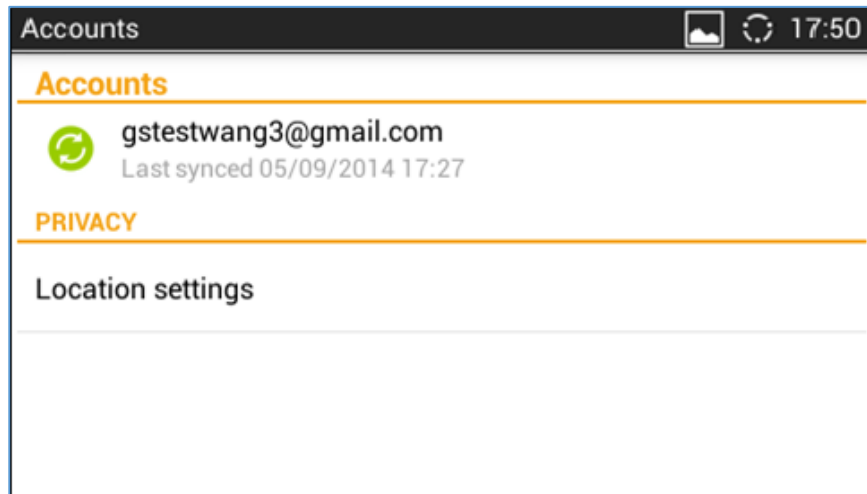

Figure 12: GXV3240 Accounts Sync Up Settings - Google Account Synced Up

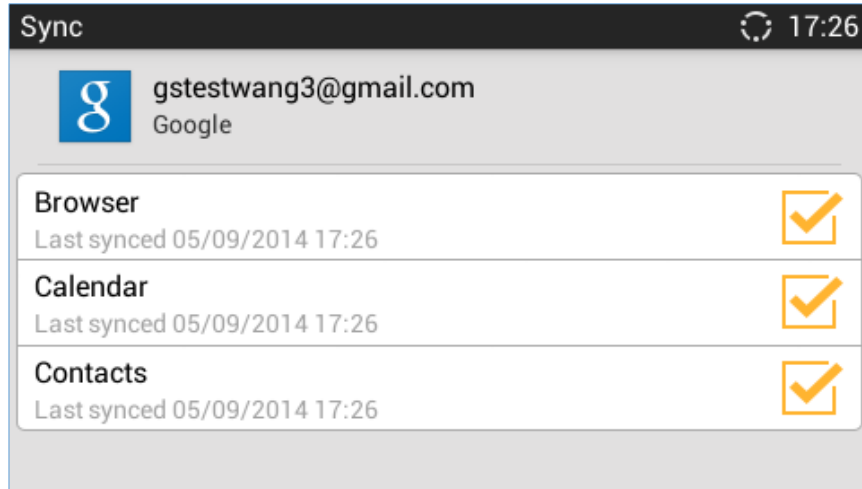

Figure 13: GXV3240 Accounts Sync up Settings - Select Browser, Calendar and Contacts

Additionally, if Google account is set up as the above figures show, users will be automatically signed in after downloading Google Play from GS Market.

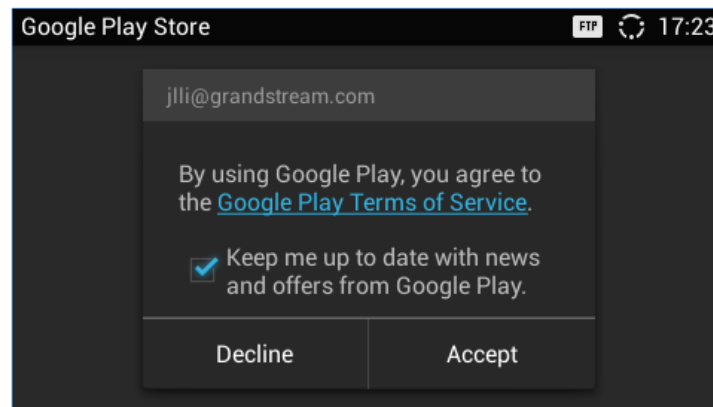

Figure 14: GXV3240 Google Play Account

Register to Failover SIP Server

The GXV3240 supports registration to failover SIP server, following steps need to be achieved in order to make this configuration:

1. Configure Account 1, Account 2, etc. With the SIP extension.
2. Under “Account X → Call Settings” of each account set the same “Virtual Account Group”, for instance “Virtual Account Group 1”.
3. Navigate to “Advanced Settings → Call Features” and check “Virtual Account Group Avaya Mode”.
4. Navigate to “Advanced Settings → Call Features” and set “Virtual Account Group Concurrency Register” to the same number as the virtual account, we set it in our example to “1”.
5. Click on “Save” and “Apply” to apply the settings.

The phone will register to the first SIP server and only when the primary SIP server fail, the phone will send register request to the secondary SIP server.



Date & Time

- **Enable and use specified NTP server address.** Assign the URL or IP Address of NTP Server.
- **Set date.** Set the current date for the GXV3240.
- **Set time.** Set the time on the GXV3240 manually.
- **Select time zone.** Select time zone for the GXV3240.
- **Use 24-hour format.** Check/uncheck to display the time using 24-hour time format or not. For example, in 24-hour format, 13:00 will be displayed instead of 1:00 p.m.
- **Choose date format.** Select the format of year, month and day for the date to be displayed.

Accessibility

Accessibility allows users to set up their GXV3240 in order to make it user-friendly for people who need help seeing/hearing or otherwise operating their device.

- **Services.** Shows all installed accessibility services in the GXV3240, for instance **Talkback** Service.
- **System.** This allows users to enable/disable “Magnification gestures” feature that allows to zoom in and out on the screen by triple typing in it. In this section users can also activate display “Large text” option, “Speak passwords”, “Text-to-speech output” and “Touch & hold delay” features.

About Phone

About phone lists the GXV3240's SIP account information, network status and system information.

- **Account status.** Displays the account name and registration status on the GXV3240.
- **Network status.** Displays MAC Address, Address Type, IP Address, Subnet Mask, Default Gateway, DNS Server, Alternative DNS server, NAT Type and VPN IP if any.
- **System information.** Displays the Android version, system version, recovery version, u-boot version, kernel version, hardware version and CPE version of the GXV3240. The system version is the firmware version for the GXV3240.

Advanced Settings

- **Account**
 - Configure SIP account's registration information. Tap on one account and fill in the necessary information to register the account, which includes Account Active, Account Name, SIP Server, SIP User ID, SIP Auth ID, SIP Auth Password, Voice Mail User ID and Display Name.
 - GXV3240 supports UCM Auto Config Number feature. This feature allows the Grandstream UCM, located in the same network, automatically to assign accounts and to register them to GXV3240.



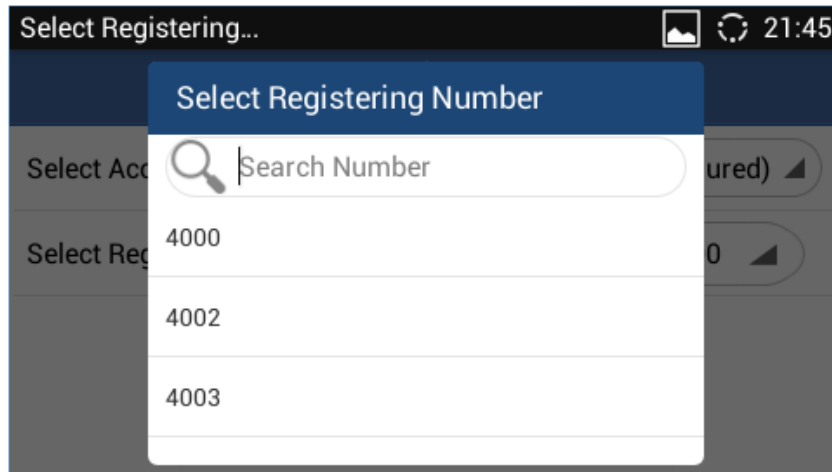

Figure 15: GXV3240 UCM Auto Config Number – Select Registering Numbers

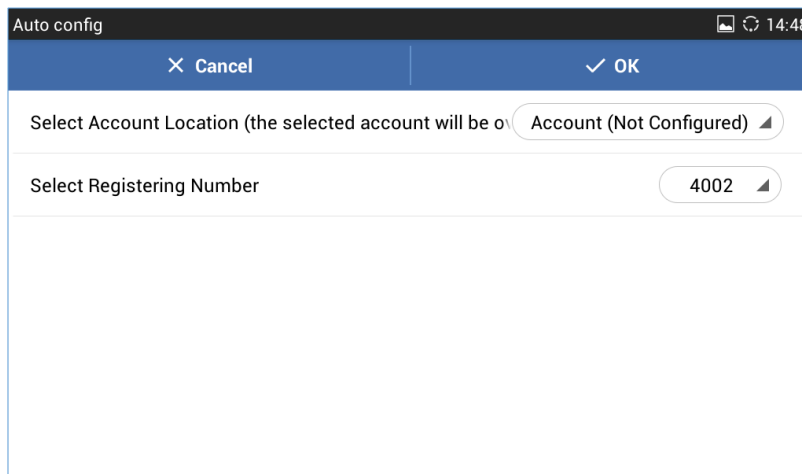

Figure 16: GXV3240 UCM Auto Config Number – Enabling Registering Number

- **Upgrade**
 - **Upgrade mode:** This field allows the user to choose the firmware upgrade method: TFTP, HTTP or HTTPS.
 - **Firmware upgrade and provisioning.** Defines the rules for automatic upgrade: Always Check at bootup, when F/W pre/suffix changes, Skip the Firmware Check.
 - **HTTP/HTTPS user name.** The user name for the HTTP/HTTPS server if set up on the server side.
 - **HTTP/HTTS password.** The password for the HTTP/HTTPS server if set up on the server side.
 - **Firmware server path.** This defines the server path for the firmware server. It can be different from the configuration server for provisioning.
 - **Config server path.** This defines the server path for provisioning. It can be different from the firmware server for upgrading.
- **Syslog**
 - **Syslog level**
 Select the level of logging for syslog. The default setting is "None". There are 4 levels: DEBUG, INFO, WARNING and ERROR.



- **Syslog server address.** The URL/IP address for the syslog server. If the GXV3240 has network connection, the phone will send the syslog packets to this server address.
- **Factory Reset.** Open and tap on **Factory Reset** to restore the GXV3240 to factory default settings.
- **Developer mode.** This mode can be used via ADB tool for advanced debugging purpose.

Multicast Paging

The GXV3240 supports the multicast paging which allows different SIP users to listen to a page from a common multicast IP address.

- **Paging Barge**

For the following we will assume that the option "Paging Priority Active" is not checked

- We suppose that we have 5 listening addresses filled on the GXV3240, from priority 1 to 5, and Paging Barge is set to "2", only priority 1 and 2 multicasts will hold the call and play multicast. For the multicast 3/4/5 have no priority to "cover/override" the call.
 - If Paging Barge is set to "Disable", no multicast can be prior to the call, which means the call is the highest priority.
- **Paging Priority Active**
 - We suppose that we have 5 listening addresses filled on the GXV3240, from priority 1 to 5, and Paging Priority Active is set to "Yes", low priority multicast will be "covered/overridden" by higher priority ones.
 - For example, the GXV3240 is listening to a multicast from priority 2 address, only priority 1 multicast can override the current multicast, but priority 3/4/5 multicast will be ignored.
 - If we have 5 listening addresses filled in GXV3240, from priority 1 to 5, and Paging Priority Active is set to "No", no new multicast can override the current one no matter what priority it has.
 - For example, GXV3240 is listening to a multicast from address 4, priority 1/2/3/5 multicast will all be ignored.

GXV3240 WEB GUI SETTINGS

The GXV3240 embedded Web server responds to HTTP/HTTPS GET/POST requests. Embedded HTML pages allow users to configure the application phone through a Web browser such as Microsoft's IE, Mozilla Firefox, Google Chrome and etc.



Figure 17: GXV3240 Web GUI - Login

Access GXV3240 Web GUI

The GXV3240 Web GUI URL is ***http://Phone-IP-Address***, where the Phone-IP Address is the IP address displayed on the GXV3240 desktop account widget.



Figure 18: GXV3240 Main Screen - IP Address

To access the GXV3240 Web GUI:

1. Connect the computer to the same network as the phone.
2. Make sure that the phone is turned on and shows its IP address on the account widget of the desktop.
3. Open a Web browser on your computer.
4. Enter the phone's IP address in the address bar of the browser.



5. Enter the administrator's login and password to access the Web Configuration Menu. The default login name and password for the administrator is "admin" and "admin". The default login name and password for the end-user is "user" and "123".

**Note:**

- The computer has to be connected to the same sub-network as the phone. This can be easily done by connecting the computer to the same hub or switch as the phone connected to. In absence of a hub/switch (or free ports on the hub/switch), please connect the computer directly to the PC port on the back of the phone.
 - If the phone is properly connected to a working Internet connection, the phone will display its IP address. This address has the format: xxx.xxx.xxx.xxx, where xxx stands for a number from 0-255. Users will need this number to access the Web GUI. For example, if the phone shows 192.168.40.154, please enter "http://192.168.40.154" in the address bar of the browser.
-

Saving Changes

When changing any settings on the web UI, always SUBMIT them by pressing the **Save** button on the bottom of the page, and then clicking the **Apply** button on the top of the page to apply the configuration changes. For those options with  next to it in the Web page, users must reboot the phone for the changes to take effect.

Definitions

This section describes the options in the GXV3240 Web GUI. As mentioned, you can log in as an administrator or an end user.

- **Status:** Displays the Account Status, Network Status, and System Info of the phone.
- **Account (1-6):** To configure each of the SIP accounts.
- **Advanced Settings:** To configure General Settings, Call Features, Video Settings, Tone Generator and MPK Settings for MPK App.
- **Maintenance:** To configure Network Settings, Wi-Fi Settings, Time Settings, Web/SSH Access, Upgrade, Syslog, Logcat, Debug, Language, TR-069, Contacts, Device Manager, etc.

The following table shows the web pages accessible by end user and administrator, respectively.

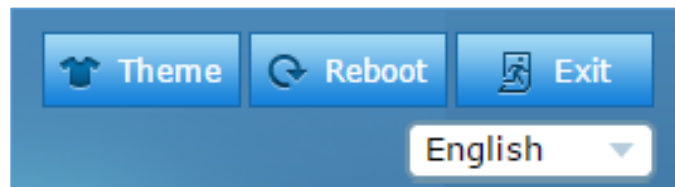

Table 6: GXV3240 Web Access

User Type	Username	Default Password	Accessible Web Pages
Administrator	admin	admin	All pages
End User	user	123	<ul style="list-style-type: none"> Status: Account Status, Network Status, System Info. Advanced Settings: Tone Generator, MPK General Settings, MPK LCD Settings, and MPK EXT Settings. Maintenance: Network Settings, Wi-Fi Settings, Time Settings, Web/SSH Access, Logcat, Debug, Language, Contacts, LDAP Book, Broadsoft, Device Manager.

Toolbar

The web UI tool bar is on the upper right corner of the web UI page.

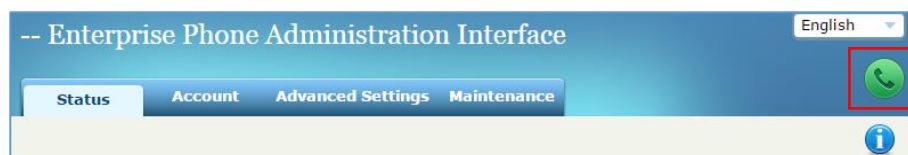

Figure 19: GXV3240 Web UI Tool Bar

- **Theme:** Select the web UI style to display the web page.
- **Reboot:** Reboot the phone.
- **Exit:** Log out from the web UI.
- **English:** Select the display language for the web UI.

Click-To-Dial

The GXV3240 allows users to manage their call using the Click to Dial feature which permits to initiate and receive the call using the Web GUI. To user the Click to Dial feature, please refer the following steps:

1. Access the Web GUI using the administrator username and password (the default username / password is: admin/admin).
2. Press the Click to Dial button to access the call menu as displayed on the following screenshot.

Figure 20: Click to Dial Feature

3. Select the account to be used, call mode (call, paging or IP call), call type (audio or video).
4. Type the number to call under “Dial Number” field and press **Dial** button or answer an incoming call by pressing on Answer / Reject buttons as displayed on the following screenshots:

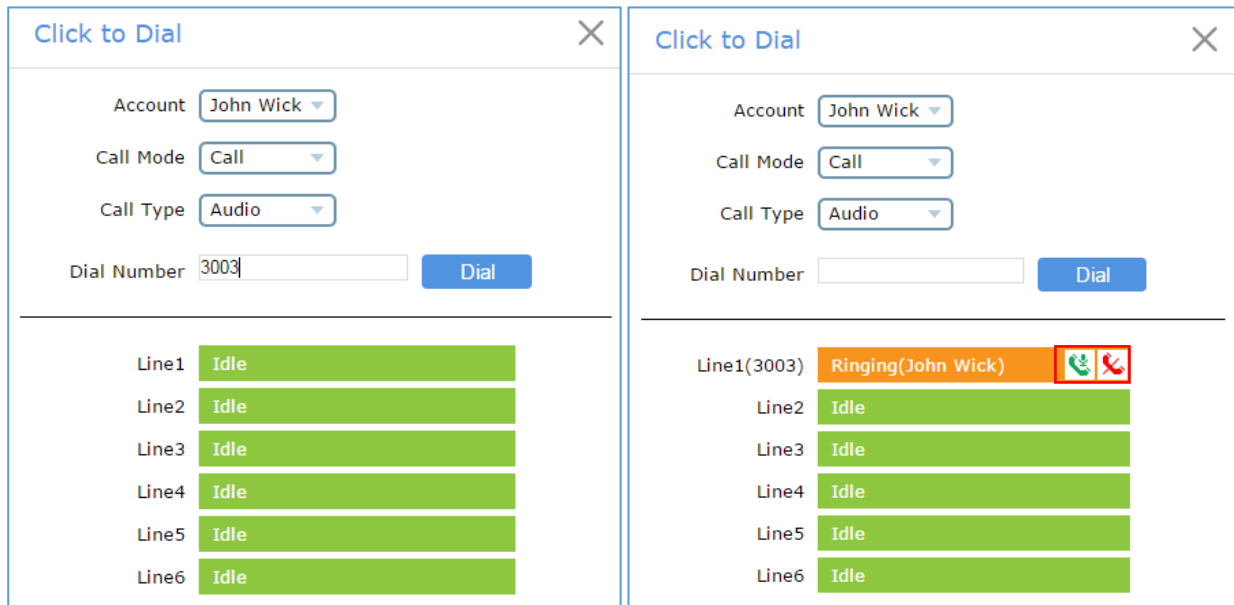



Figure 21: Click to Dial Menu and Calls Status

Note:

- The Click to Dial menu display also the status of the ongoing calls with a detailed information about the account such the name, account number, line used ...
- To leave the Click to Dial menu press on exit button .

Status Page Definitions

Status/Account Status

Account	6 SIP accounts on the phone. By default, the 6 th SIP account is the IPVideoTalk account built-in with the phone.
Number	SIP User ID for the account.
SIP Server	URL or IP address, and port of the SIP server.
Status	Registration status for the SIP account.

Status/Network Status

MAC Address	Global unique ID of device, in HEX format. The MAC address will be used for provisioning and can be found on the label coming with original box and on the label located on the back of the device.
NAT Type	Type of NAT connection used by the phone.
Address Type	Configured address type: DHCP, Static IP or PPPoE.



IPv4 Address	IP address of the phone.
Subnet Mask	Subnet mask of the phone.
Default Gateway	Default gateway of the phone.
DNS Server 1	DNS Server 1 of the phone.
DNS Server 2	DNS Server 2 of the phone.
IPv6 Address Type	Configured address type: DHCP, Static IP or PPPoE.
IPv6 Address	IPv6 address of the phone.
IPv6 DNS Server 1	IPv6 DNS Server 1 of the phone.
IPv6 DNS Server 2	IPv6 DNS Server 2 of the phone.

Status/System Info

Product Model	Product model of the phone.
Hardware Revision	Hardware version number.
Part Number	Product part number.
System Version	Firmware version ID. This is the main software release version, which is used to identify the software system of the phone.
Recovery Version	Recovery image version.
Boot Version	Boot code version.
Kernel Version	The kernel version.
Android™ Version	The Android™ OS version: 4.2.2.
TP Firmware Version	Touch panel LCD screen firmware version.
System Up Time	System up time since the last reboot.

Account Page Definitions

GXV3240 has six lines that can be configured to accommodate 6 independent SIP accounts. Each SIP account has an individual configuration page.

Account/General Settings

Account Active	Indicates whether the account is active. The default value for the IPVideoTalk account (Account 6) is "Yes" and the default value for the first five accounts is "No".
Account Name	Configures name associated with each account to be displayed on LCD. Note: The account name will be trimmed automatically to remove extra whitespaces and tabulations at the beginning and end of the string. For example, if the account name is set to "account1 ", it will be automatically corrected to "account1".



SIP Server	Specifies the URL or IP address, and port of the SIP server. This should be provided by VoIP service providers (ITSP).
SIP User ID	Configures the user account information, provided by your VoIP service provider (ITSP). It's usually in the form of digits similar to phone number or actually a phone number.
SIP Authentication ID	Configures the SIP service subscriber's Authenticate ID used for authentication. It can be identical to or different from the SIP User ID.
SIP Authentication Password	Configures the account password required for the phone to authenticate with the ITSP (SIP) server before the account can be registered. After saving, it will appear as hidden for security purpose.
Voice Mail Access Number	Sets if the phone system allows users to access the voice messages by pressing the MESSAGE key on the phone. This ID is usually the VM portal access number. For example, in UCM6100 IPPBX, *97 could be used.
Name	Specifies the SIP server subscriber's name (optional) that will be used for Caller ID display. The configured content will be included in the From, Contact and P-Preferred-Identity headers of SIP INVITE message.
Show Account Name Only	Enables to display the account name, if it is checked, the user ID will be hidden and the account name will be displayed only.
Tel URI	<p>Indicates E.164 number in "From" header by adding "User=Phone" parameter or using "Tel:" in SIP packets, if the phone has an assigned PSTN Number.</p> <ul style="list-style-type: none"> • Disabled: Will use "SIP User ID" information in the Request-Line and "From" header. • User=Phone: "User=Phone" parameter will be attached to the Request-Line and "From" header in the SIP request to indicate the E.164 number. If set to "Enable". • Enabled: "Tel:" will be used instead of "sip:" in the SIP request. <p>Please consult your carrier before changing this parameter.</p>

Account/Network Settings

Outbound Proxy	Configures the IP address or the domain name of the primary outbound proxy, media gateway, or session border controller. It's used by the phone for firewall or NAT penetration in different network environments. If a symmetric NAT is detected, STUN will not work and only an outbound proxy can provide a solution.
Secondary Outbound Proxy	Sets the IP address or the domain name of the secondary outbound proxy, media gateway, or session border controller. The phone system will try to connect the secondary outbound proxy only if the primary outbound proxy fails.



DNS Mode	<p>Defines which DNS service will be used to lookup IP address for SIP server's hostname. It can be selected from the dropdown list:</p> <ul style="list-style-type: none"> • A Record • SRV • NATPTR/SRV <p>If it needs DNS SRV resource, which DNS server response more than one result, it should be set to "SRV" or "NATPTR/SRV".</p> <p>The default setting is "A Record".</p>
DNS SRV Fail-over Mode	<p>The option will decide which IP is going to be used in sending subsequent SIP packets (ex: Register refresh requests) after the list of IPs for SIP server host is resolved with DNS SRV.</p> <p>Default (prefer server with lowest SRV priority): The phone will always prefer to send SIP requests to the available server having the lowest priority, and in case it's down it contacts the next one, but once the server having lowest priority is UP again, the phone will switch over to this one.</p> <p>Saved one until DNS TTL (Stay on responding IP until DNS timeout): On this mode, the phone will resolve DNS SRV records and tries to send the request to the server having lowest priority and if it doesn't respond, it will move on to the next IP until one of the servers responds, once this happen the phone will keep contacting this responding IP until DNS timeout (30 minutes) before starting over.</p> <p>Saved one until no response (Stay on responding IP until its failure): On this mode, the phone will send SIP requests to the last responding IP, and it doesn't failover/switchover to the next one until this responding server is down.</p>
NAT Traversal	<p>Specifies which NAT traversal mechanism will be enabled on the phone system. It can be selected from the dropdown list:</p> <ul style="list-style-type: none"> • NAT NO • STUN • Keep-alive • UPnP • Auto • VPN <p>If the outbound proxy is configured and used, it can be set to "NAT NO".</p> <p>If set to "STUN" and STUN server is configured, the phone system will periodically send STUN message to the SUTN server to get the public IP address of its NAT environment and keep the NAT port open.</p> <p>STUN will not work if the NAT is symmetric type.</p>



	<p>If set to “Keep-alive”, the phone system will send the STUN packets to maintain the connection that is first established during registration of the phone. The “Keep-alive” packets will fool the NAT device into keeping the connection open and this allows the host server to send SIP requests directly to the registered phone.</p> <p>If it needs to use OpenVPN to connect host server, it needs to set it to “VPN”. If the firewall and the SIP device behind the firewall are both able to use UPNP, it can be set to “UPNP”. The both parties will negotiate to use which port to allow SIP through. The default setting is "Keep-alive".</p>
Proxy-Require	Adds the Proxy-Required header in the SIP message. It is used to indicate proxy-sensitive features that must be supported by the proxy. Do not configure this parameter unless this feature is supported on the SIP server.

Account/SIP Settings

SIP Registration	Allows the phone system to send SIP Register messages to the proxy/server. The default setting is "Yes".
Unregister Before New Registration	Controls whether to clear SIP user's information by sending un-register request to the proxy server. When set to "All", the un-registration is performed by sending a REGISTER message with “Contact” header set to * and Expires=0 parameters to the SIP server when the phone starts pre-registration after rebooting. If set to "Instance", the phone only cleans the current SIP user's info by sending REGISTER message with “Contact” header set to concerned SIP user's info and Expires=0 parameters to the SIP server. The default setting is "Instance".
Register Expiration (m)	Configures the time period (in minutes) in which the phone refreshes its registration with the specified registrar. The default setting is 60. The maximum value is 64800 (about 45 days).
Re-register before Expiration (s)	Specifies the time frequency (in seconds) that the phone sends re-registration request before the Register Expiration. The default setting is 0. The range is from 0 to 64,800.
Registration Retry Wait Time (s)	Configures the time period (in seconds) in which the phone will retry the registration process in the event that is failed. The default setting is 20. The maximum value is 3600 (1 hour).
Local SIP Port	Determines the local SIP port used to listen and transmit. The default setting is 5060 for Account 1, 5062 for Account 2, 5064 for Account 3, 5066 for Account 4, 5068 for Account 5, and 5070 for Account 6. The valid range is from 5 to 65535.
SUBSCRIBE for MWI	Configures the phone system to subscribe voice message service. If it is set to "Yes", the phone system will periodically send SIP SUBSCRIBE



	message for Message Waiting Indication service. GXV3240 phone system supports both synchronized and non-synchronized MWI. Default is "No".
Enable SIP OPTIONS Keep Alive	Enables SIP OPTIONS to track account registration status so the phone will send periodic OPTIONS message to server to track the connection status with the server. The default setting is "No".
SIP OPTIONS Keep Alive Interval (s)	Configures the time interval when the phone sends OPTIONS message to SIP server. The default setting is 30 seconds, which means the phone will send an OPTIONS message to the server every 30 seconds. The default range is 1-64800.
SIP OPTIONS Keep Alive Maximum Tries	Configures the maximum times of sending OPTIONS message consistently from the phone to server. Phone will keep sending OPTIONS messages until it receives response from SIP server. The default setting is "3", which means when the phone sends OPTIONS message for 3 times, and SIP server does not respond this message, the phone will send RE-REGISTER message to register again. The valid range is 3-10.
Enable Session Timer	Allows the phone system to use the session timer, when set to "Yes", it will be added in the SIP INVITE message to notify the server. Default setting is "Yes"
Session Expiration (s)	Configures the phone system's SIP session timer. It enables SIP sessions to be periodically "refreshed" via a SIP request (UPDATE, or re-INVITE). If there is no refresh via an UPDATE or re-INVITE message, the session will be terminated once the session interval expires. Session Expiration is the time (in seconds) where the session is considered timed out, provided no successful session refresh transaction occurs beforehand. The default setting is 180. The valid range is from 90 to 64800.
Min-SE (s)	Determines the minimum session expiration timer (in seconds) if the phone act as a timer refresher. The default setting is 90. The valid range is from 90 to 64800.
UAC Specify Refresher	Sets which party will refresh the active session if the phone makes outbound calls. If it is set to "UAC" and the remote party does not support Refresher feature, the phone system will refresh the active session. If it is set to "UAS", the remote party will refresh it. If it is set to "Omit", the header will be omitted so that it can be selected by the negotiation mechanism. The default setting is "Omit".
UAS Specify Refresher	Specifies which party will refresh the active session if the phone receives inbound calls. If it is set to "UAC", the remote party will refresh the active session. If it is set to "UAS" and the remote party does not support refresh feature, the phone system will refresh it. The default setting is "UAC".
Force INVITE	Sets the SIP message type for refresh the session. If it is set to "Yes", the Session Timer will be refreshed by using the SIP INVITE message.



	Otherwise, the phone system will use the SIP UPDATE or SIP OPTION message. Default setting is "No".
Caller Request Timer	Sets the caller party to act as refresher by force. If set to "Yes" and both party support session timers, the phone will enable the session timer feature when it makes outbound calls. The SIP INVITE will include the content "refresher=uac". The default setting is "No".
Callee Request Timer	Sets the callee party to act as refresher by force. If set to "Yes" and the both parties support session timers, the phone will enable the session timer feature when it receives inbound calls. The SIP 200 OK will include the content "refresher=uas". The default setting is "No".
Force Timer	Configures the session timer feature on the phone system by force. If it is set to "Yes", the phone will use the session timer even if the remote party does not support this feature. If it is set to "No", the phone will enable the session timer only when the remote party supports this feature. To turn off the session timer, select "No". The default setting is "No".
Enable 100rel	Activates the PRACK (Provisional Acknowledgment) method. PRACK improves the network reliability by adding an acknowledgement system to the provisional Responses (1xx). It is set to "Yes", the phone system will response to the 1xx response from the remote party. Default is "No".
Caller ID Display	Specifies which header tag will be used from the SIP INVITE message for the Caller ID display. If it is set to Auto, the phone system will use the one of the available headers in the priority hierarchy of P-Asserted Identify Header, Remote-Party-ID header and FROM header. If it is set to "From Header", it will use the FROM header information for the Caller ID. If it is set to "Disabled", all the incoming calls Caller ID will be displayed with "Unavailable". The default setting is "Auto".
Use Privacy Header	Determines if the Privacy header will be presented in the SIP INVITE message and if it includes the caller info in this header. If it is set to "Default", the Privacy Header will be omitted in INVITE when "Huawei IMS" special feature is active. If set to "Yes", it will always be presented. If set to "No", it will always be omitted. The default setting is "Default".
Use P-Preferred-Identity Header	Specifies if the P-Preferred-Identity Header will be presented in the SIP INVITE message. If set to "default", the P-Preferred-Identity Header will be omitted in SIP INVITE message when "Huawei IMS" special feature is active. If set to "Yes", the P-Preferred-Identity Header will always be presented. If set to "No", it will be omitted. The default setting is "Default".
Use P-Access-Network-Info Header	Specifies if the P-Access-Network Header will be presented in the SIP INVITE message.
Use P-Emergency-Info Header	Specifies if the P-Emergency-Info Header will be presented in the SIP INVITE message.



Ignore Alert-Info header	Incoming alert info header from the SIP server will be ignored and default configured ringtone will be played.
SIP Transport	Determines which network protocol will be used to transport the SIP message. It can be selected from TCP/UDP/TLS. Default setting is "UDP".
SIP URI Scheme When Using TLS	Defines which SIP header, "sip" or "sips", will be used if TLS is selected for SIP Transport. The default setting is "sip".
Use Actual Ephemeral Port in Contact with TCP/TLS	Determines the port information in the Via header and Contact header of SIP message when the phone system use TCP or TLS. If set to No, these port numbers will use the permanent listening port on the phone. Otherwise, they will use the ephemeral port for the particular connection. The default setting is "No".
Symmetric RTP	Configures if the phone system enables the symmetric RTP mechanism. If it is set to "Yes", the phone system will use the same socket/port for sending and receiving the RTP messages. The default setting is "No".
RTP IP Filter	Receives the RTP packets from the specified IP address and Port by communication protocol. If it is set to "IP Only", the phone only receives the RTP packets from the specified IP address based on the communication protocol; If it is set to "IP and Port", the phone will receive the RTP packets from the specified IP address with the specified port based on the communication protocol. The default setting is "Disable".
RTP Timeout Timer (s)	Forces the call to disconnect automatically when there is no RTP stream for a specific timeout. Default is 30 seconds.
Support SIP Instance ID	Determines if the phone system will send SIP Instance ID. The SIP instance ID is used to uniquely identify the device. If set to "Yes", the SIP Register message Contact header will include +sip.instance tag. The default setting is "Yes".
Validate Incoming SIP Messages	Specifies if the phone system will check the incoming SIP messages caller ID and CSeq headers. If the message does not include the headers, it will be rejected. The default setting is "No".
Check SIP User ID for Incoming INVITE	Configures the phone system to check the SIP User ID in the Request URI of the SIP INVITE message from the remote party. If it doesn't match the phone's SIP User ID, the call will be rejected. If set to "Yes", this feature will be active. The default setting is "No".
Authenticate Incoming INVITE	Configures the phone system to authenticate the SIP INVITE message from the remote party. If set to "Yes", the phone will challenge the incoming INVITE for authentication with SIP 401 Unauthorized response. The default setting is "No".
Allow Unsolicited REFER	Configures whether to dial the number carried by Refer-to after receiving SIP REFER request actively. If it is set to "Disabled", the phone will send



	<p>error warning and stop dialing. If it is set to "Enabled/Force Auth", the phone will dial the number after sending authentication, if the authentication failed, then the dialing will be stopped. If it is set to "Enabled", the phone will dial up all numbers carried by SIP REFER.</p>
Only Accept SIP Requests from Known Servers	<p>Configures the phone system to answer the SIP request from saved servers/ If set to "Yes", only the SIP requests from saved servers will be accepted; and the SIP requests from the unregistered server will be rejected. The default setting is "No".</p>
Add Auth Header On RE-REGISTER	<p>Configure if the SIP account needs to add Auth header in RE-REGISTER.</p> <ul style="list-style-type: none"> • If the option is checked, device will always add authentication header in REGISTER. • If the option is unchecked, device will only send authentication for the first REGISTER. <p>Note: The P-value is 2359, 2459, 2559, 2659, 2759, 2859 for account 1/2/3/4/5/6. 0 - No, 1 - Yes.</p>
Allow SIP Reset	<p>Configures whether to allow SIP Notification message to perform factory reset on the phone. The default setting is "No".</p>
Allow Sync Phonebook via SIP Notify	<p>Allows users to synchronize XML phonebook upon receiving SIP NOTIFY message with header Event: sync-contacts.</p> <p>Note: Received SIP NOTIFY will be first challenged for authentication purpose before contacting configured server to download XML phonebook. The parameters used are the ones configured at [Download (XML Phonebook)]. The authentication can be done either using admin credentials (if no SIP account is configured) or using SIP account credentials.</p> <p>The default setting is "Yes".</p>
SIP T1 Timeout	<p>Defines an estimate of the round-trip time of transactions between a client and server. If no response is received in T1, the figure will increase to 2*T1 and then 4*T1. The request re-transmit retries would continue until a maximum amount of time define by T2. The default setting is 0.5 sec.</p>
SIP T2 Interval	<p>Specifies the maximum retransmit time of any SIP request messages (excluding the SIP INVITE message). The re-transmitting and doubling of T1 continues until it reaches the T2 value. The default setting is 4 sec.</p>
SIP Timer D Interval	<p>Defines the amount of time that the server transaction can remain when unreliable response (3xx-6xx) received. The valid value is 0-64 seconds.</p>
Remove OBP from Route	<p>Configures the phone system to remove the outbound proxy URI from the Route header. This is used for the SIP Extension to notify the SIP server that the device is behind a NAT/Firewall. If it is set to "Yes", it will remove the Route header from SIP requests.</p> <p>The default setting is "No".</p>



Check Domain Certificate	Sets the phone system to check the domain certificates if TLS/TCP is used for SIP Transport. The default setting is "No".
Validate Certification Chain	Configures whether to validate certification chain, when TLS/TCP is configured for SIP Transport. If this is set to "Yes", phone will validate server against the new certificate list. The default setting is "No".
Enable SCA (Shared Call Appearance)	Enables/disables the Shared Call Appearance (the Broadsoft Standard) feature for this account. If it is set to "Yes", the phone system can update and share account status with another device. The default setting is "No".
Enable Barge-In	Enables/disables the Barge-In feature. If it is set to "Yes", the user could tap the SCA account to barge into an active session with another shared line. The default setting is "No".
Auto-filling Pickup Feature Code	Sets if the phone system will add the configured feature code to retrieve parked calls. If it is set to "Yes", the "Pickup Feature Code" configured will be automatically prepended on the phone's dial pad when retrieving the parked call. The default setting is "Yes". This option will be active only if "Special Mode" is set to "Broadsoft" and "Enable SCA" is set to "Yes".
Pickup Feature Code	Configures the pickup feature code for call park. If "Auto-filling Pickup Feature Code" is set to "Yes", this feature code will be automatically filled in on the dial pad when picking up the parked call. This option is used when "Special Mode" is set to "Broadsoft" and "Enable SCA" is set to "Yes".
Line-seize Timeout	Defines line-seize expiration timer. For Shared Call Appearance, the phone must send a SUBSCRIBE request for the line-seize event package whenever a user attempts to take the shared line off hook. The default value is 15 seconds. The valid range is from 15 to 60.

Account/Codec Settings

DTMF	<p>Specifies the mechanism to transmit DTMF (Dual Tone Multi-Frequency) signals. There are 3 supported modes: in audio, RFC2833, or SIP INFO.</p> <ul style="list-style-type: none"> • In audio, which means DTMF is combined in the audio signal (not very reliable with low-bit-rate codecs); • RFC2833, which means to specify DTMF with RTP packet. Users could know the packet is DTMF in the RTP header as well as the type of DTMF; • SIP INFO, which use SIP info to carry DTMF. The defect of this mode is that it's easily to cause desynchronized of DTMF and media packet if the SIP and RTP messages are required to transmitted respectively. <p>The default setting is "RFC2833".</p>
DTMF Payload Type	Configures the RTP payload type that indicates the transmitted packet contains DTMF digits. Valid range is from 96 to 127. Default value is 101.



Preferred Vocoder	Lists the available and enabled Audio codecs for this account. Users can enable the specific audio codecs by moving them to the selected box and set them with a priority order from top to bottom. This configuration will be included with the same preference order in the SIP SDP message.
Preferred Video Codecs	Lists the available and enabled Video codecs for this account. Users can enable the specific video codecs by moving them to the selected box and set them with a priority order from top to bottom. This configuration will be included with the same preference order in the SIP SDP message.
Codec Negotiation Priority	Configures the phone to use which codec sequence to negotiate as the callee. When set to "Caller", the phone negotiates by SDP codec sequence from received SIP Invite; When set to "Callee", the phone negotiates by audio codec sequence on the phone. The default setting is "Callee".
Use First Matching Vocoder in 200OK SDP	Configures the phone to use the first matching codec in the 200OK message. The default value is 0.
ILBC Frame Size	Sets the ILBC (Internet Low Bitrate Codec) frame size if ILBC is used. Users can select it from 20ms or 30ms. The default setting is 30ms.
G726-32 ITU Payload	Configures G726-32 payload type for ITU packing mode. Payload 2 is static and payload dynamic is dynamic. The default setting is "2".
G726-32 Dynamic PT	Specifies the G726-32 payload type, and the valid range is 96 to 127. The default setting is "126".
Opus Payload Type	Defines the desired value (96-127) for the payload type of the Opus codec. The default value is 123.
Enable RFC5168 Support	Enables/disables RFC5168 mechanism for video calls. RFC5168 allows SIP party to request the sender to refresh its video frame in H.264, or refresh the full picture in VP8. The default setting is "No".
Enable Video FEC	When enabled, the video sender will temporarily allocate part of the bandwidth to one data channel to send FEC data to system, thus to improve the video quality the receiver gets. Enabling this function will take up part of bandwidth and reduce call rate. The default setting is "Yes".
Video FEC Mode	When set to 0, FEC is not sent by separate port. If set 1, FEC is sent by separate port. Default setting is 0.
FEC Payload Type	Configures FEC payload type. The range is 96-127. The default setting is 120.
Packetization Mode	Configures the packetization mode for the video packets during the video calls. Three modes are supported: <ul style="list-style-type: none"> • Single NAL Unit Mode: the packetization mode will be negotiated as single NAL unit mode when dial video calls, if the other party does not support the negotiation, then single NAL unit mode will be used for video encoding by default.



	<ul style="list-style-type: none"> • Non-Interleaved Mode: the packetization mode will be negotiated as Non-interleaved mode when dial video calls, If the other party does not support negotiation, then the Non-interleaved mode will be used for video encoding by default; • Prefer Non-Interleaved Mode: the packetization mode will be negotiated as prefer Non-interleaved mode when dial video calls, if the other party does not support the negotiation, then prefer Non-interleaved mode will be used for video encoding by default. <p>The default setting is "Prefer Non-Interleaved Mode".</p>
H.264 Image Size	<p>Sets the H.264 image size. It can be selected from the dropdown list.</p> <ul style="list-style-type: none"> • 720P • 4CIF • VGA • CIF • QVGA • QCIF <p>The default setting is 720P.</p> <p>Note: For some network environment, the default setting "720P" might be too high that causes no video or video quality issue during video call. In this case, please change "H.264 Image Size" to "VGA" or "CIF" and change "Video Bit Rate" to "384kbps" or lower.</p>
Use H.264 Constrained Profiles	<p>Configures that whether to set H.264 constrained profiles. Default setting is "No".</p>
H.264 Profile Type	<p>Selects the H.264 profile type from the dropdown list.</p> <ul style="list-style-type: none"> • Baseline Profile (Default setting) • Main Profile • High Profile • BP/MP/HP <p>Note: Lower levels are easier to decode, but higher levels offer better compression.</p> <p>Usually, for the best compression quality, choose "High Profile"; for playback on low-CPU machines or mobile devices, choose "Baseline Profile". If "BP/MP/HP" is selected, all three profiles "Baseline Profile" "Main Profile" and "High Profile" will be used for negotiation during video decoding to achieve the best result. This is usually used in video conference when there is higher requirement on the video.</p>



Video Bit Rate	<p>Configures the bit rate for video call. It can be selected from the dropdown list. The default setting is 2048 kbps. The valid range is from 32 – 2048 kbps.</p> <p>Note: The video bit rate can be adjusted based on the network environment. Increasing the video bit rate may improve video quality if the bandwidth is permitted. If the bandwidth is not permitted, the video quality will decrease due to packet loss. For some network environment, the default setting “720P” might be too high that causes no video or video quality issue during video call. In this case, please change “H.264 Image Size” to “VGA” or “CIF” and change “Video Bit Rate” to “384kbps” or lower.</p>
SDP Bandwidth Attribute	<p>Sets SDP bandwidth attribute. It can be selected from the drop-down list.</p> <ul style="list-style-type: none"> • Standard: use AS format in session level; use TIAS format in media level • Media Level: use AS format in media level • Session Level: use AS format in session level • None: no modifications in the session format <p>The default setting is “Media Level”.</p> <p>Note: Please do not modify this setting without knowing the session format supported by the server. Otherwise, it might cause video decoding failure.</p>
H.264 Payload Type	<p>Specifies the H.264 codec message payload type format. The default setting is 99. The valid range is from 96 to 127.</p>
H.263 Encoder Resolution	<p>Configures H263 encoder resolution to use. The default setting is CIF.</p>
SRTP Mode	<p>Sets if the phone system will enable the SRTP (Secured RTP) mode. It can be selected from dropdown list:</p> <ul style="list-style-type: none"> • Disable • Enabled but not forced • Enabled and forced <p>SRTP uses encryption and authentication to minimize the risk of denial of service. (DoS). If the server allows to use both RTP and SRTP, it should be configured as “Enabled but not forced”.</p> <p>The default setting is “Disable”.</p>
SRTP Key Length	<p>Configures all the AES (Advanced Encryption Standard) key size within SRTP. It can be selected from dropdown list; the default setting is “AES128&256 bit”:</p> <ul style="list-style-type: none"> • AES128&256 bit • AES 128 bit • AES 256 bit <p>If set to “AES 128&256 bit”, the phone system will provide both AES 128 and 256 cipher suite for SRTP. If set to “AES 128 bit”, it only provides 128-bit cipher suite; if set to “AES 256 bit”, it only provides 256-bit cipher suite.</p>



Enable SRTP Key Life Time	Defines the SRTP key life time. When this option is set to be enabled, during the SRTP call, the SRTP key will be valid within 2^{31} SIP packets, and phone will renew the SRTP key after this limitation. Default is “Yes”.
Silence Suppression	Enables the silence suppression/VAD feature. If it is set to “Yes”, when silence is detected, a small quantity of VAD packets (instead of audio packets) will be sent during the period of no talking. If set to “No”, this feature is disabled. The default setting is “No”.
Voice Frames Per TX	Configures the number of voice frames transmitted per packet. When configuring this, it should be noted that the “ptime” value for the SDP will change with different configurations here. This value is related to the codec used and the actual frames transmitted during the in payload call. For end users, it is recommended to use the default setting, as incorrect settings may influence the audio quality. The default setting is 2.
RTCP Destination	Configures a remote server URI where RTCP messages will be sent to during an active call.

Account/Call Settings

Start Video Automatically	Permits the phone system to enable the video feature automatically when it makes an outbound call. If set to “Yes”, the video codec attributes will be included in the SIP INVITE message. Or the attributes will not be included. The default setting is “Yes”.
Video Layout	Sets the phone to enable full-screen mode or just display the remote video in full screen mode while answering a video call. Default setting: “Default”.
Remote Video Request	Configures the preference to handle video request from the remote party during an audio call. It can be selected from the dropdown list. <ul style="list-style-type: none"> • Prompt: A message will be prompted if a video request is received. Users can select “Yes” to establish video or “No” to reject the request. • Accept: Video request will be accepted automatically and video will be established. • Deny: Video request will be rejected automatically. The default setting is “prompt”.
Disable Presentation	Configures whether to receive presentation information during conference with GVC3200. If set to “Yes”, the device will disable receiving presentation during conference. The default setting is “Yes”.
Dial Plan Prefix	Configures the digits prepended to the dialed number.
Disable DialPlan	Enables/disables the Dialplan mechanism for different cases. If the specific case is checked, the Dialplan mechanism will be disabled. <ul style="list-style-type: none"> • Dial Page: It controls the pattern of dialing numbers from the keypad, phone app and account widget.



	<ul style="list-style-type: none"> • Contact: It controls the pattern of dialing numbers from local, LDAP and Broadsoft contacts. • Incoming Call History: It controls the pattern of dialing numbers from inbound call logs. • Outgoing Call History: It controls the pattern of dialing numbers from outbound call logs. • MPK&Click2Dial: It controls the pattern of dialing numbers from MPK app and the link on the webpage. The default setting is unchecking all the cases.
Dial Plan	<p>Configures the dial plan to establish the expected number and pattern of digits for a telephone number. This parameter configures the allowed dial-plan for the phone.</p> <p>Dial Plan Rules:</p> <ol style="list-style-type: none"> 1. Accepted Digits: 1,2,3,4,5,6,7,8,9,0 , * , #, A,a,B,b,C,c,D,d,+ 2. Grammar: x – any digit from 0-9; <ol style="list-style-type: none"> a) xx+ or xx. – at least 2-digit numbers b) xx – only 2-digit numbers c) ^ - exclude d) [3-5] – any digit of 3, 4, or 5 e) [147] – any digit of 1, 4, or 7 f) <2=011> - replace digit 2 with 011 when dialing g) - the OR operand h) \+ - add + to the dialing number <ul style="list-style-type: none"> • Example 1: {[369]11 1617xxxxxxx} <p>Allow 311, 611, and 911 or any 10 digit numbers with leading digits 1617</p> <ul style="list-style-type: none"> • Example 2: {^1900x+ <=1617>xxxxxxx} <p>Block any number of leading digits 1900 or add prefix 1617 for any dialed 7 digit numbers</p> <ul style="list-style-type: none"> • Example 3: {1xxx[2-9]xxxxxx <2=011>x+} <p>Allow any number with leading digit 1 followed by a 3 digits number, followed by any number between 2 and 9, followed by any 7 digit number OR allow any length of numbers with leading digit 2, replacing the 2 with 011 when dialed.</p> 3. Default: Outgoing – { x+ \+x+ *x+ **x*x+ } <p>Allow any number of digits, OR any number with a leading +, OR any number with a leading *, OR any number with a leading * followed by a 2 digits number and a *. To dial + from keypad, press on 0 until + appears on LCD.</p> <p>Example of a simple dial plan used in a Home/Office in the US:</p> <pre>{^1900x. <=1617>[2-9]xxxxxx 1[2-9]xx[2-9]xxxxxx 011[2-9]x. [3469]11 }</pre>



	<p>Explanation of example rule (reading from left to right):</p> <ul style="list-style-type: none"> • ^1900x. – prevents dialing any number started with 1900 • <=1617>[2-9]xxxxxx – allow dialing to local area code (617) numbers by dialing 7 numbers and 1617 area code will be added automatically • 1[2-9]xx[2-9]xxxxxx - allow dialing to any US/Canada Number with 11 digits length • 011[2-9]x. – allow international calls starting with 011 • [3469]11 – allow dialing special and emergency numbers 311, 411, 611 and 911 <p>Note: In some cases, where the user wishes to dial strings such as *123 to activate voice mail or other applications provided by their service provider, the * should be predefined inside the dial plan feature. An example dial plan will be: {*x+} which allows the user to dial * followed by any length of numbers.</p>
Refer-To Use Target Contact	<p>Sets the phone system to use the target's Contact header tag to the Refer-To header in the SIP REFER message during an attended transfer. The default setting is "No".</p>
Auto Answer	<p>Sets the phone system to allow to answer an incoming call automatically.</p> <ul style="list-style-type: none"> • If it is set to "Yes", the phone will automatically enable the speaker phone to answer all the incoming calls after a short reminding beep. • If set to "Enable Intercom/Paging", it will automatically answer the incoming calls whose SIP INVITE or SIP UPDATE include auto-answer-after=0 tag in the call-info header. <p>Default setting is "Yes".</p>
Play warning tone for Auto Answer Intercom	<p>When this option is enabled, the phone will play a warning tone When auto-answering intercom. The default setting is "yes".</p>
Intercom Barging	<p>Configures whether to answer the incoming intercom call when there is already an active call on the phone. When "Intercom Barging" is enabled, and if the current active call is an intercom call, the incoming intercom call will be automatically rejected; otherwise if the current active call is not an intercom call, the current active call will be put on hold and the incoming intercom will be automatically answered. When "Intercom Barging" is disabled, a prompt will show up indicating the incoming intercom call without interrupting the current active call. The default setting is disabled.</p>
Custom Alert-Info for Auto Answer	<p>Configures the Alert-info contents. The phone will answer the paging call automatically only when the info or the header matches this content. The default setting is blank, which means answer all paging calls automatically.</p> <p>Note: This feature will be showed when "Auto-answer" is set to "Enable Intercom/Paging".</p>



Auto Preview	<p>Configures whether to turn on video to preview the video of the caller. If set to "Yes", the user can view the video and hear the caller on the incoming page when there is an incoming call. If set to "Yes with Ringing", the caller can view the video of the caller and hear the ringtone on the incoming page, but cannot hear the caller. Default Value: "No".</p> <p>Note: If Auto Answer function has been enabled, this function does not take effect.</p>
Send Anonymous	<p>Sets the phone system to make an anonymous outgoing call. If it's set to "Yes", the "From" header in the SIP INVITE messages will be set to anonymous, essentially blocking the Caller ID to be displayed. The default setting is "No".</p>
Anonymous Call Rejection	<p>Rejects the calls whose SIP INVITE message includes Anonymous information in from header when enabled. The default setting is "No".</p>
Call Log	<p>Categorizes the call logs saved for this account. If it is set to "Log All", all the call logs of this account will be saved. If set to "Log Incoming/Outgoing Calls (Missed Calls Not Record)", the whole call history will be saved other than missed call. If it is set to "Disable Call All", none of the call history will be saved. If it is set to "Don't Prompt Missed Call", the phone will log the missed call histories, but there is no prompt to indicate the missed calls on phone LCD.</p> <p>The default setting is "Log All".</p>
Special Feature	<p>Configures phone's settings to meet different vendors' server requirements. Users can choose from Standard, BroadSoft, CBCOM, RNK, China Mobile, ZTE IMS, Mobotix, ZTE NGN, Huawei IMS, NEC, WorldStone, or Baudisch Door System, depending on the server type. The default setting is "Standard".</p> <p>Note: When set "Special Feature" to "Baudisch Door System", groups of door system URL and User ID will show up for users. Up to 100 entries can be configured.</p> <ul style="list-style-type: none"> Baudisch Door System URL: This is used to input IP address or URL of the system to make sure the account could identify the call from door system (up to 100 entries). Users can set HTTP authentication credentials on the URL for Door Systems that require authentication to send the HTTP stream. The URL format will be the following: http://username:password@192.168.1.150/goform/stream?cmd=get&channel=4 Baudisch Door System SIP User ID: This is used to configure the User ID of door system. Once configured, only the call from this User ID would use door system while other calls use standard mode.



	<ul style="list-style-type: none"> • Enable preview: This is used to enable video preview for the incoming Baudisch call. When enabled, users can view the video stream on the incoming call screen before answering. This setting is disabled by default.
Configure Door System	<p>Specifies which calls from specific ID will be using door system; others will use standard mode. Click on “Configure” to access the configuration page, fill in IP address or URL and user ID.</p> <p>Notes:</p> <ul style="list-style-type: none"> • Users can have DTMF programmable key displayed in call screen under Baudisch door system feature. • Users can also have the call menu after receiving an audio call under Baudisch door system feature.
Feature Key Synchronization	<p>Synchronizes the BroadSoft standard call feature. If it is enabled, the phone will send SIP SUBSCRIBE message to the server and receive SIP NOTIFY message from the server to synchronize the DND, Call Forwarding and Call Center features. The default setting is “Disable”.</p>
Enable BroadSoft Call Park	<p>Configures whether to send SUBSRIBE message to BroadSoft server to obtain Call Park notifications. The default setting is “No”.</p>
Enable Call Features	<p>Configures the local start command feature. If it is set to “Yes”, the feature will be enabled to recognize the local star code command. Otherwise, it will be disabled. The default setting is “No”.</p>
No Key Entry Timeout (s)	<p>Determines the expiration timer (in seconds) for no key entry. The dialed digit will be send out if no other digits entered within the set period. The default value is 4 seconds. The valid range is from 1 to 30, and when it is set to 0, this setting is disabled (Example: after user enters digits, device would not dial out automatically). This feature does not work if the dialer page is entered via the Account Widget on the phone.</p>
Ring Timeout (s)	<p>Defines the expiration timer (in seconds) for the rings with no answer. The default setting is 60. The valid range is from 10 to 300.</p>
Virtual Account Group	<p>Categorizes accounts in server mode groups, the accounts in the same group will be combined as one and the account widget will display the Caller ID in the account with lowest ID. The phone can answer any incoming calls to each account in groups.</p> <p>If user makes an outbound call, the phone system will use the lowest ID account by default. If the account fails or SIP INVITE message is timeout, the phone system will failover to the next account in the group with higher account ID. If all the accounts are not available in the group, the phone system will traverse all the accounts in the group and notify the end users the session is failed.</p>



Transfer on 3-way Conference Hang up	Transfers conference from hosted party when hang up, thus other parties can continue the conference without interruption. The default setting is unchecked.
Use # as Dial Key	Treats “#” as the “Send” (or “Dial”) key when set to “Yes”. If set to “No”, this “#” key can be included as part of the dialed number or it will be used as redial key when the input area has no number (please make sure the dial plan is properly configured to allow dialing # out). Default setting is “Yes”.
DND Call Feature On	Configures the feature code to enable the DND (Do Not Disturb) feature for this account. If it is configured, the phone will dial the feature code automatically when the DND feature is enabled.
DND Call Feature Off	Configures the feature code to disable the DND (Do Not Disturb) feature for this account. If it is configured, the phone will dial the feature code automatically when the DND feature is disabled.
Conference URI	Configures the network-based conference URI (the BroadSoft Standard). If it is configured, end user needs to tap the N-way key during the conference to transfer the host to the remote media server.
BroadSoft Call Center	Enables the BroadSoft Call center feature for this account. If set to “Yes”, the soft key “CallCenter” is displayed on LCD dial screen for the BroadSoft account. User can access different BroadSoft Call Center agent features via this softkey. Please note that “Feature Key Synchronization” will be enabled regardless of this setting. The default setting is “No”.
Hoteling Event	Enables or disables the BroadSoft Hoteling event feature. It must turn on the BroadSoft call center feature before enabling this feature. With “Hoteling Event” enabled, user can access the Hoteling feature option by tapping the “Call Center” key in the Phone app. Default setting is “No”.
Call Center Status	Obtains the BroadSoft Call center status, when set to “Yes”, the phone will send SIP SUBSCRIBE message to the server to get call center status. It must turn on the BroadSoft call center feature before enabling this feature. The default setting is “No”.
Account Ring Tone	Configures the ringtone for the account. Users can set ringtones from the dropdown list. User can also import customized ringtone from LCD Setting menu. The customized ringtone file name will also be showed up in the dropdown list that allows user to select.
Programmable Keys	Configures the MPK keys in the Phone app. It MUST use unregistered accounts to set the programmable keys. Once this key is configured on the unregistered account, the MPK key will be displayed on the account tab in the Phone app. Key Mode: It is used to setup the keys feature in the dropdown list. <ul style="list-style-type: none"> • Speed Dial: Press to dial the number in the UserID field.



	<ul style="list-style-type: none"> • Busy Lamp Field (BLF): Monitor other account status. • Call Transfer: Transfer the current active call to other party. • Call Intercom: Initiate an Intercom/paging call. • Speed Dial via Active Account: It is similar to Speed Dial but it will use current active account. For example, if the phone is off-hook and Account 2 is active, it will make an outbound via Account 2. • Dial DTMF: Dial the DTMF digits in the User ID filed. • Call Park: Park a call to the specified parking orbit or retrieve a call from the orbit. • Multicast Paging: This is an option for multicast sending. Enter the corresponding programmable key description in Name field, and multicast sending address in User ID field. <p>Account: It is used to bundle the programmable with selected account.</p> <p>Name: It is used to name the programmable keys.</p> <p>User ID: It is used to configure the parameter of the programmable key.</p> <p>DTMF Content: When key mode is set to Dial DTMF it configures the UserID for the corresponding MPK mode when the accounts being configured as MPK.</p> <p>Dial DTMF Condition: When key mode is set to Dial DTMF it configures whether the DTMF button display on incoming call interface, outgoing call interface or previewing incoming video call interface. The default setting is "Incoming/Outgoing Call".</p> <p>Note: When using Dial DTMF, user can configure for each account a specific DTMF button and they all will be displayed during an audio or a video call.</p>
Call Forward Type	<p>Sets the Call Forwarding feature for this account.</p> <ol style="list-style-type: none"> 1. None: Disable call forwarding feature. 2. Unconditional: Set to forward all calls to a specified account. 3. Time based: Set the call forwarding rule based on time. The system can forward the incoming calls to the accounts of In Time Forward to and Out Time Forward to. 4. Others: Set the call forwarding rule based on following account status. <ul style="list-style-type: none"> ✓ Forward when Busy: the call will be forward to number set under "Busy To" when the account is busy. ✓ Forward when No Answer: The call will be forwarded to the number set under "No Answer To" after the configured timeout. ✓ Forward when DND: When the phone is on DND mode the call will be forwarded to number configured under "DND To".



Matching Incoming Caller ID	<p>Specifies the rules for the incoming calls. If the incoming caller ID or Alert Info matches the number, pattern or Alert Info text rules, the phone will play the selected distinctive ringtone. The rule policy:</p> <ul style="list-style-type: none"> • Specific caller ID number. For example, 8321123; • A defined pattern with certain length using x and + to specify, where x could be any digit from 0 to 9. Samples: xx+ : at least 2-digit number; xx : only 2-digit number; [345]xx: 3-digit number with the leading digit of 3, 4 or 5; [6-9]xx: 3-digit number with the leading digit from 6 to 9. • Alert Info text Users could configure the matching rule as certain text (e.g., priority) and select the custom ring tone mapped to it. The custom ring tone will be used if the phone receives SIP INVITE with Alert-Info header in the following format: Alert-Info: <http://127.0.0.1>; info=priority
Distinctive Ring Tone	<p>Selects the distinctive ring tone if the incoming caller ID matched the specified Matching Incoming Caller ID rule. If so, the phone will play the selected ringtone.</p>
Upload Local MOH Audio File	<p>Loads the MOH (Music on Hold) file to the phone. Click on “Browse” button to upload the music file from local PC. The MOH audio file has to be in .wav or .mp3 format.</p> <p>Note: Please be patient while the audio file is being uploaded. It could take more than 3 minutes to finish the uploading especially the file size is large. The button will show as “Processing” during the uploading. Once done, it will show as “Browse” again. Click on “Save” on the bottom of the web page and “Apply” on the top of the web page to save the change.</p>
Enable Local MOH	<p>Plays local MOH file if the call is being hold by the phone. Default is “No”.</p>

Advanced Settings Page Definitions

Advanced Settings/General Settings

Local RTP Port	<p>Defines the local RTP-RTCP port pair used to listen and transmit.</p> <p>If it is configured with X, in channel 0 the port X will be used for audio RTP message, the port X+1 for audio RTCP message, the port X+2 for video RTP message and the port X+3 for video RTCP. In Channel 1, each port number will be incremented by 4 for each message. This increment rule will apply to other channels and other port numbers.</p> <p>By default, the Account 1 will use Channel 0, Account 2 Channel 1,</p>
-----------------------	---



	<p>Account 3 Channel 2, Account 4 Channel 3, and Account 5 Channel 4 and Account 6 Channel 5. If an account needs to establish multiple session simultaneously, the system will use the ports in the next available channels.</p> <p>The default value is 5004. The valid range is from 1024 to 65400.</p>
Use Random Port	<p>Forces the phone system to use random ports for both SIP and RTP messages. This is usually necessary when multiple phones are behind the same full cone NAT. Default is “No”.</p> <p>Note: This parameter must be set to “No” for Direct IP Calls to work.</p>
Disable in-call DTMF display	<p>Enables/disables the phone system to omit the DTMF digits displaying from the LCD screen. The default setting is “No”.</p>
Enable Enterprise Contacts Timeout Auto Search	<p>Configures whether to display the matched content automatically in search of the LDAP and Broadsoft Contacts when timeout. If set to “No”, users need to click the “Search” button to search the matched contacts mentioned above. The default setting is “Yes”.</p>
Hide LDAP Contacts	<p>Enables/disables the phone system to omit the LDAP contacts will from LCD screen. If it is enabled, end user is not allowed to use it in the Contact app. The default setting is “No”.</p>
Hide Local Call History	<p>Enables/disables the phone system to omit the Local Call History will from LCD screen. It only valid when the BroadSoft Xsi call logs feature is enabled. If it is enabled, end user will enter the BroadSoft Xsi call logs directly from the Call History app from the LDC screen. Default is “No”.</p>
Keep-alive Interval (s)	<p>Specifies how the phone system will send a Binding Request packet to the SIP server in order to keep the “ping hole” on the NAT router to open. The default setting is 20 seconds. The valid range is from 10 to 160.</p>
STUN Server	<p>Configures the URI of STUN (Simple Traversal of UDP for NAT) server. The phone system will send STUN Binding Request packet to the STUN server to learn the public IP address of its network. Only non-symmetric NAT routers work with STUN. The default setting is “stun.ipvideotalk.com”.</p>
Use NAT IP	<p>Configures the IP address for the Contact header and Connection Information in the SIP/SDP message. It should ONLY be used if it’s required by your ITSP. The default setting is keep the box blank.</p>
Permission to Install/Uninstall Apps	<p>Allows users to set permission to install/uninstall apps via web browser, SD card and GS Market. The default value is 0.</p>
Guest Login	<p>Enables the desking mode. End users need to configure the SIP domain or/and the SIP failover domain name before implementing this feature. Users also should enter SIP username and password of the Primary server or secondary SIP server manually on LCD after reboot the phone. The default setting is “No”.</p>
Guest Login Timeout (m)	<p>Configures the timeout to quit the hot desking mode if there are not any operations on the phone. The default setting is “Never”.</p>



Guest Login PIN Code	Defines PIN code for guest login. If hot desking mode is enabled and guest login timeout set to Never, user needs to enter the PIN code to login. Default is NULL
SIP Domain	Configures the SIP domain under Avaya mode. Fill in the SIP server address to choose the registered server before login Avaya server. This function should be used with Outbound Proxy option under Account→Network Settings.
SIP TLS Certificate	Specifies SSL certificate used for SIP over TLS in X.509 format.
SIP TLS Private Key	Specifies TLS private key used for SIP over TLS in X.509 format.
SIP TLS Private Key Password	Specifies SSL Private key password used for SIP Transport in TLS/TCP.
Custom Certificate	This feature allows user to upload custom certificate. The priority of certificate is SIP TLS/Certificate/Private Key (Only SIP TLS used) > Custom Certificate > Individual Certificate > General Certificate.
Import Custom Certificate	Uploads certificate file from PC using BROWSE button. The certificate file should be “.pem”, “.crt”, and “.cer” or “.der” format. The Browse button will turn to “Processing” and back to “Browse” once the uploading finished. Note: Users can also delete uploaded custom certificate by clicking on “Delete”.
Trusted CA Certificates	Uses the certificate for Authentication if “Check Domain Certificates” is set to “Yes” under “Account” → “SIP Settings”.
Import Trusted CA Certificates	Uploads certificate file from PC using BROWSE button. The certificate file should be “.pem”, “.crt”, and “.cer” or “.der” format. The Browse button will turn to “Processing” and back to “Browse” once the uploading finished.

Advanced Settings/Call Features

Always Ring Speaker	Determines if the speaker will play the ringtone if the speaker channel is not set as default channel. If set to “Yes”, the phone will force to play the ring speaker in speaker channel. The default setting is “No”. End user might need this feature when the headset is connected.
Virtual Account Group Avaya Mode	Combines the first three accounts as a virtual group to place and answer calls. This feature is designed for the Avaya customer.
Virtual Account Group Concurrence Register	Configures the amount of concurrent accounts in virtual account group. If the total amount of virtual group accounts is “N”, the number of accounts the user sets is “N”, then the phone will register the first n accounts.
Auto Conference	Allows the phone system to invite all call parties into a conference by pressing the CONF key. If it is disabled, the end user has to add each call party to conference manually. The default setting is “No”.



Display Soft Keyboard	Enables the QWERTY soft keyboard in the phone app/dialer page. If it is set to “Yes”, the soft keyboard will pop up by tapping the input box. Default setting is “No”. It is recommended to disable the dial plan of the dial page on the Account Settings page, or the call may fail if dial characters not conform to the dial plan.
Always Display Dialer Interface	Forces the phone to enter the dialer page on the LCD screen. If it is enabled, the phone LCD will display the dialer interface automatically from LCD screen idle mode (screen saver mode or screen sleep mode). It needs coordinate with Dialer Interface Display Interval setting. Default is “No”.
Dialer Interface Display Interval (m)	Configures the timer for the Dialer Interface Priority Display. The timer will be started from the LCD screen goes to idle mode (screen saver mode or screen sleep mode). If the Dialer Interface Priority Display feature is enabled, the phone LCD will display the dialer interface automatically from LCD screen idle mode (screen saver mode or screen sleep mode) after the timer expired. If it is configured with 0, the phone LCD screen will display the dialer interface when user wakes up the phone from the screensaver mode or screen sleep mode whatever the last apps is running. It needs coordinate with Dialer Interface Display. The default setting is 1.
Filter Characters	Sets the characters for filter when dial out numbers. Users could set up multiple characters. For example, if set to “[()-]”, when dial (0571)-8800-8888, the character “()-“ will be automatically filtered and dial 057188008888 directly. Note: The space also can be used and it will be automatically filtered. The default value is “[()-]”.
Disable Call-Waiting	Disables the call waiting feature. If it is checked, the phone system will reject the second incoming call during an active session without user’s knowledge. But this missed call record will be saved to remind users. The default setting is “No”.
Disable Call-Waiting Tone	Sets the phone system to play the call waiting tone if there is another incoming call. If it is set to “Yes”, the phone will only display the indicator on the LCD screen for another incoming call. The default setting is “No”.
Disable DND Reminder Ring	Configures the phone to play the DND reminder ringtone for the incoming call if the DND feature is enabled. If it set to “Yes”, the phone will keep mute instead of playing a ring splash to indicate an incoming call when DND is enabled. Default is “No”.
Disable Direct IP Call	Configures the phone system to allows the end users to make an outbound IP call. If it is set to “Yes”, the phone will hide the IP call feature and end users will not be allowed to make an outbound IP call. The default is “No”.
Use Quick IP-Call mode	Sets the phone to automatically fills in the first three octets to make an outbound IP call. If set to “Yes”, users can dial an IP address under the same LAN/VPN segment by entering the last octet in the IP address. To



	dial quick IP call, off-hook the phone and dial #XXX (X is 0-9 and XXX <=255), the phone will make direct IP call to aaa.bbb.ccc.XXX where aaa.bbb.ccc comes from the local IP address regardless of subnet mask. #XX or #X are also valid so leading 0 is not required. No SIP server is required to make quick IP call. The default setting is "No".
Disable Video Call Feature	Disables the video call feature on GXV32xx. The default setting is "No".
Disable Conference	Disables the conference. When set to "Yes", the phone will block the conference application. The default setting is "No".
Disable Transfer	Disables the transfer feature. When set to "Yes", the phone system will block the TRANSFER key on the LCD screen. The default setting is "No".
Hold Call Before Completing Transfer	When this option is set to "Yes" the phone holds the second call before completing the attended transfer (it sends the INVITE method to hold the call before sending the REFER method).
Default Transfer Mode	Sets the default transfer mode for the phone system. If the Blind Transfer, Attended Transfer or Attended Transfer Only mode is set, the phone system will use the specific mode to transfer an active call. The users still have privilege to switch the mode on the LCD screen when they tap the transfer key. The default setting is "Blind Transfer".
Enable Transfer via non-Transfer Programmable Key	When set to "Yes", users can perform Blind Transfer during the call to the number configured in the BLF programmable key by pressing "More" then "MPK" and the BLF number afterwards.
In-Call Dial Number on Pressing Transfer Key	Configures the code to be sent as DTMF when pressing transfer button.
Disable Active MPK	Once enabled, when MPK users receiving an incoming call, the extension board will jump to call page to display all incoming calls. Default is "No"
Escape # as %23 in SIP URI	Determines which characters will be included in the SIP INVITE URI if end users input #. If it is set to "Yes", the phone system will replace the # by %23. Otherwise, it will include # in the SIP INVITE message. The default setting is "Yes".
Offhook Auto Dial	Configures the User ID/extension to dial automatically when the phone is off-hook. The phone will use the first account to dial the configured numbers out. The default setting is "No".
Offhook Auto Dial Delay(s)	Defines the timer for warm line dialing. After the timer expires, the phone system will dial the configured number in off-hook Auto Dial automatically. If it is not configured, the configured number will be dialed immediately.
Offhook/Onhook Timeout (s)	If configured, the phone will exit the dial-up screen when timeout after Offhook or Onhook. The default settings is 30s. The valid range is 10-60s.



Enable Function for Incoming Call	<p>Enables the preview feature for the incoming video calls. Defines the function for the incoming video call. If it is set to “Preview”, the phone system will pop up the PREVIEW key on the LCD screen when there is an incoming video call, and users could tap on it to check video caller without answering the incoming video call (the call will keep playing ringback on the caller side). The default setting is “None”.</p> <p>Note: By pressing the preview button, the phone will send the SIP 183 message to the caller’s camera, based on SIP RFC3261; the caller’s camera should start then sending the stream to the phone.</p> <p>At any time, the GXV32xx user can press the "Answer" button. If done then the phone will send the SIP 200OK and call will be fully established.</p>
Mute Key Functions While Idle	<p>Configures the mute key functions while the phone is in idle. Users could set to "DND", "Idle Mute" and "Permanent Mute". If set to "DND", once pressed the mute key, The DND mode will be on and incoming calls of all accounts will be rejected; If set to "Idle Mute", once pressed the mute key, users will answer all incoming calls in mute mood; If set to "Permanent Mute", once pressed the mute key, users will answer/dial up all calls in mute mood. All the press for the mute key operations mentioned above should be done when the phone is in idle. The mute key function in a call is still mute/unmute. The default setting is "DND".</p>
Dial DTMF Button Size	<p>Configures the size of the DTMF button on call interface. Default is “Large”.</p>
Dial DTMF Button Color	<p>Configures the color of the DTMF button on call interface. The default setting is “Red”.</p>
Attended conference	<p>Configures whether to query the host when add conference members. If check "Yes", the meeting in process will be held when the host clicks the Add Member button on the conference interface to invite members. When the invited members answer the call and agree to attend, the host would manually add the members to conference and continue the conference. If not check, the members will join meeting automatically after answer the meeting. The default setting is "No".</p>
Use 3rd Party App as Basic Phone	<p>Please enter the package and activity of the 3rd party app that substitutes GS phone application, separated by "/". e.g.com.broadsoft.ucone.androidtablet/com.broadsoft.android.common.activity.LauncherActivity.</p> <p>After input, when the user Offhook or click the phone application, it will automatically enable the configured app to enter the corresponding interface.</p> <p>The default setting is blank, which means use GS phone application.</p>



Auto UnHold When Press the Line Key	Configures when there are multiple lines, whether to UnHold the line automatically when click the line being held, and hold the line in the primary call. Note: the hold situation which is set manually will not be UnHold automatically. The default setting is "No".
Record Mode	Configures phone recording mode. Three modes are available: <ol style="list-style-type: none"> 1. Record Locally: The phone will use the local tape recorder for call recording, and the audio file will be saved in accordance with the tape recorder setup. 2. Record on PortaOne: The phone will send SIP INFO message with "record" header to the server. 3. Record on UCM: The phone will send the recording feature code to the UCM server to request for recording and the recording function will be executed by the UCM. The default setting is "Record Locally".
Enable Auto Record When Call Established	When set to "Yes", every call established will be recorded automatically in the specified store location. The usage of external SD card is recommended.
Enable Diversion Info Display	Set the option to "Yes" to display Diversion header information on incoming calls.

Advanced Settings/Video Settings

Video Frame Rate	Configures video frame rate for SIP video call from "5 frames/second", "15 frames/second", "25 frames/second", "30 frames/second" and "Variable frames rate". The default setting is 15 frames/second. The video frame rate is adjustable based on network conditions. Increasing the frame rate will significantly increase the amount of data transmitted, therefore consuming more bandwidth. The video quality will be affected due to packet loss if extra bandwidth is not allocated.
Video Display Mode	Configures the video display mode to "Original proportion", "Equal proportional cutting" or "Proportional add black edge". If set to "Original proportion", the phone displays video in its original proportion. If the video display proportion is different from the one of the phone, the phone will stretch or compress video to display it; If set to "Equal proportional cutting", the phone will cut video to meet its own display proportion; If set to "Proportional add black edge", the phone will display video in its original proportion. If it still exists spare space, the phone will add black edge on it. The default setting is "Equal proportional cutting".



Enable Frame Skipping in Video Decoder	<p>Enables the phone system for frame skipping in video decoder. If it is enabled, the video decoder will skip the P frame and start decoding from the next I frame.</p> <p>Enabling this option will help reduce flickering in the video when the bandwidth is limited in the network environment.</p> <p>The default setting is "Yes".</p>
---	--

Advanced Settings/Tone Generator

Auto Config CPT by Region	<p>Configures whether to choose Call Progress Tone automatically by region. If set to "Yes", the phone will configure CPT (Call Progress Tone) according to different regions automatically. If set to "No", you can manual configure CPT parameters.</p> <p>The default setting is "No".</p>
Lock Volume	<p>When enabled, volume adjustment is locked so that end users cannot change adjust the volume.</p>
Call Progress Tones: Dial Tone Second Dial Tone Ring Back Tone Busy Tone Reorder Tone Confirmation Tone Call-Waiting Tone PSTN Disconnect Tone	<p>Configures tone frequencies according to user preference. By default, the tones are set to North American frequencies. Frequencies should be configured with known values to avoid uncomfortable high pitch sounds.</p> <p>Syntax: f1=val,f2=val [,c=on1/off1[-on2/off2[-on3/off3]]]; (Frequencies are in Hz and cadence on and off are in 10ms) ON is the period of ringing ("On time" in "ms") while OFF is the period of silence. In order to set a continuous ring, OFF should be zero. Otherwise it will ring ON ms and a pause of OFF ms and then repeats the pattern.</p> <p>Please refer to the document below to determine your local call progress tones: http://www.itu.int/ITU-T/inr/forms/files/tones-0203.pdf</p>
Call-Waiting Tone Gain	<p>Adjusts the call waiting tone volume. Users can select "Low", "Medium" or "High". The default setting is "Low".</p>
Default Ring Cadence	<p>Defines the ring cadence for the phone. The default setting is: c=2000/4000.</p>

Advanced Settings/Multicast Paging

Allow Multicast in DND Mode	<p>When enabled the device can receive multicast paging if DND is activated.</p>
Paging Barge	<p>Sets the threshold of paging calls. If the paging call's priority is higher than the threshold, the existing call will be hold and the paging call will be answered. Otherwise, the existing call does not be affected. If it is set to Disable, any paging call will not be answered. Default setting is "Disable".</p>



Paging Priority Active	Determines if a new paging call whose priority is higher than the existing paging call will be answered. If it is checked, this feature will be enabled. The default setting is disabled.
Multicast Paging Codec	Selects the codec type for the multicast paging call. This list includes PCMU, PCMA, G726-32, G722, and G729A/B.
Enable Multicast Paging Video	Enables the video feature to establish a multicast paging call. The default setting is disabled.
Multicast Paging Video Codec	Sets the video codec for the multicast paging call. Default setting is "H.264".
Multicast Paging Image Size	Sets the video image size for the multicast paging call. This list includes 720P, 4CIF, VGA, CIF, QVGA, and QCIF.
Multicast Paging Video Bit Rate	Determines the video bit rate for the multicast paging call. The default setting is "256 kbps".
Multicast Paging Video Frame Rate	Configures the video frame rate for the multicast paging call. This list includes "15 frames/second", "25 frames/second", "30 frames/second", and "Variable frames rate".
Multicast Paging H.264 Profile Type	Specifies the H.264 codec profile type for the multicast paging call. This list includes "Baseline Profile", "Main Profile", and "High Profile". Note: Lower profile is easier to decode, while higher profile has higher compress rate. Usually, use Baseline profile for low CPU Performance device, and choose high profile for video conference.
Multicast Paging H.264 Payload Type	Determines the H.264 codec payload type for the multicast paging call. The default setting is "99".
Multicast Listening Address	Configures the IP address and port number for monitoring multicast paging call. When the initiator initiates a call, answer the call and display listening address and tag of the monitoring target. This feature supports Video Multicast, when the initiator initiates Video Multicast, it will automatically add the number 2 on the port of the listening address. Reboot the phone to make changes take effect. The valid IP address ranges from 224.0.0.0 to 239.255.255.255. Users may also fill the label for each listening address corresponding to the priority.

Advanced Settings/GDS Settings

GDS Name	Specifies the name to identify the GDS3710. Note: The GXV3240 support up 10 GDS items.
GDS Number	Specifies the GDS number which is the SIP user ID configured on GDS or the IP address of the GDS itself, if the GDS is using IP call.
GDS Password	Determines the GDS password which should match the one configured on "Remote PIN to Open the Door" field on GDS settings.



For more details about connecting the GXV32xx with GDS3710 Door System please refer to following guide:
http://www.grandstream.com/sites/default/files/Resources/Connecting_the_GDS3710_with_GXV32XX_Configuration_Guide.pdf

Advanced Settings/MPK General Settings

Enable MPK Auto Arrangement	<ul style="list-style-type: none"> The phone will make smart arrangement according to the order set on the web GUI when set to “Yes”. The phone will make arrangement according to the sequence of the extension boards (firstly arrange the first page of all extension boards, then the second page when set to “No”.
BLF Call-pick Prefix	Configures the prefix prepended to the BLF extension if the phone answers a call to the monitored party by the BLF key. The default setting is ** for each account.
Event List URI	Determines the event list BLF URI on the phone to monitor the extensions in the list with MPK keys. This feature is based on BroadSoft standard. It requires filling in the BLF ID to the box. For example, if the server provides the URI: BLF123@myserver.com , this field should be filled with BLF123. Then the monitored extensions will be populated in the MPK app or Extension Board (if supported).
Force BLF Call-pickup by Prefix	Uses the prefix for BLF Call-pickup. The default setting is “No”.
Auto Provision Eventlist BLFs	Enables the Broadsoft Eventlist BLF keys auto provision feature. If it is enabled, the phone will provision the BLF keys automatically by the SIP NOTIFY message from the server.

Advanced Settings/MPK LCD Settings

For MPK LCD Settings section, if users want to configure LCD MPKs via web UI, users may need to configure the LCD MPKs under **MPK EXT Settings**. Since the MPKs on LCD and EXT board share the same data resources, if users configure the MPKs for EXT board, the MPKs will be also logged on LCD. This is only for GXV3240, GXV3275 has different behaviors.

Key Mode	Assigns a function to the Multi-Purpose Key in the MPK app The key mode options are: <ul style="list-style-type: none"> Speed Dial Press to dial the extension configured in UserID field. Busy Lamp Field (BLF) Monitor the extension status as configured in UserID field.
-----------------	---



	<ul style="list-style-type: none"> • Call Transfer Transfer the current active call to the extension configured in UserID field. • Call Intercom Intercom/paging to the extension configured in UserID field. • Speed Dial via Active Account Similar to Speed Dial but it will dial based on the current active account. For example, if the phone is off-hook and account 2 is active, it will call the configured extension using account 2. • Dial DTMF Dial the DTMF digits filled in UserID field during a call. • Call Park Configure the call park feature code to park or pick up the call. • Multicast Paging Configure the IP address and port for establish a multicast paging call.
BLF List	Displays the configured MPK keys. Users could change the keys order by selecting "Up", "Down", "Check All", or "Delete"
Account	Selects the SIP Account assigned with the multi-purpose keys.
Name	Configures the display name for the multi-purpose key.
UserID	Specifies the UserID for the corresponding multi-purpose key mode.
Display Format	Sets the display format for the multi-purpose keys. Users could select display "Name", "UserID", or "Name (UserID)". "Name" is the one saved in phone contacts. The default setting is "Name".
Show Display Name from Server	Permits the system to display name from server side. The default setting is "No".

Advanced Settings/MPK EXT Settings (For GXV3240 Ext Board 1/2/3/4)

Key Mode	Assigns a function to the Multi-Purpose Key in the MPK app. The key mode options are: <ul style="list-style-type: none"> • Speed Dial Press to dial the extension configured in UserID field. • Busy Lamp Field (BLF) Monitor the extension status as configured in UserID field. • Call Transfer Transfer the current active call to the extension configured in UserID field. • Call Intercom Intercom/paging to the extension configured in UserID field. • Speed Dial via Active Account Similar to Speed Dial but it will dial based on the current active account.
-----------------	--



	<p>For example, if the phone is off-hook and account 2 is active, it will call the configured extension using account 2.</p> <ul style="list-style-type: none"> • Dial DTMF Dial the DTMF digits filled in UserID field during a call. • Eventlist BLF This option is similar to the BLF option, but in this case, the PBX collects the information from the phones, and sends it out in one single notify message. PBX server has to support this feature. • Call Park Configure the call park feature code to park or pick up the call. • Multicast Paging Configure the IP address and port for establish a multicast paging call. • Speed Conference Initiate a conference to the extension configured in UserID field. • Dial Prefix When an MPK is set to "Dial Prefix" mode, pressing on the MPK will put the prefix into dial pad without dialing out.
Account	It is used to select the SIP Account assigned with the multi-purpose keys.
Name	It is used to configure the display name for the multi-purpose key.
UserID	It is used to configure the UserID for the corresponding MPK key mode.
MPK ID	It is used to identify the "MPK ID x" for "MPK x". The default number is from 1-160 for 160 MPKs in 4 GXP2200EXT boards. For example, if MPK 1's MPK ID is changed from 1 to 5, users will see configuration saved on MPK5.
Display Format	It is used to set the display format for the multi-purpose keys. Users could select display "Name", "UserID", or "Name (UserID)". "Name" is the one saved in phone contacts. The default setting is "Name".

 **Note:**

For more details on GXV3240 extension board (GXP2200EXT) and Multi-Purpose Key configurations, please refer to the GXP2200EXT user manual in the website:

<http://www.grandstream.com/support>

Maintenance Page Definitions

Maintenance/Network Settings

Preferred Internet Protocol	If IPv4 is selected, the phone will be using IPv4 addressing, otherwise, it will be using IPv6 addressing. Default is Prefer IPv4
Different Networks for Data and VoIP Calls	If set to yes different configuration can be set for Data and VoIP calls.



Address Type	Configures the appropriate network settings on the phone. Users could select from "DHCP", "Static IP" or "PPPoE"(Point-to-point Protocol over Ethernet). By default, it is set to "DHCP".
DHCP VLAN Override	Selects the DHCP Option VLAN mode. When set to "DHCP Option 132 and DHCP option 133", the phone will get DHCP option 132 and 133 as VLAN ID and VLAN priority. When set to "Encapsulated in DHCP Option 43", the phone will get values from Option 43 which encapsulate VLAN ID and VLAN priority. Note: Please make sure the "Allow DHCP Option 43 and Option 66 to Override Server" setting under maintenance→upgrade is checked. The default setting is "Encapsulated in DHCP Option 43".
DHCP Host name (Option 12)	Specifies name of the client. The name may or may not be qualified with the local domain name. This field is optional but maybe required by ISP.
DHCP Vendor Class ID (Option 60)	Exchanges vendor class ID by clients and servers to convey particular configuration or other identification information. Default is Grandstream GXV3240.
IP Address	Defines the phone's static IP address if the static IP is used.
Subnet Mask	Determines the network's subnet mask if the static IP is used.
Default Gateway	Defines the network's gateway address if the static IP is used.
DNS Server 1	Configures the primary DNS IP address if the static IP is used.
DNS Server 2	Configures the secondary DNS IP address if the static IP is used.
PPPoE Account ID	Configures the PPPoE account ID if the PPPoE is used.
PPPoE Password	Sets the PPPoE password if the PPPoE is used.
Address Type	When different networks for data and VoIP calls is selected, set the address type for the VoIP calls, users can either select DHCP or Static IP.
IP Address	Enter the IP address when static IP is used.
Subnet Mask	Enter the Subnet Mask when static IP is used.
Default Gateway	Enter the Default Gateway when static IP is used.
DNS Server 1	Enter the DNS Server 1 when static IP is used.
DNS Server 2	Enter the DNS Server 1 when static IP is used.
Alternate DNS Server	Defines the secondary DNS IP address if the static IP is used.
Second Alternate DNS Server	Configures the secondary alternate DNS IP address to failover during both the default DNS server and alternate DNS server's outage.
Show IP Address On Account Widget	Shows IP address of the phone on desktop account widget. The default setting is "Yes".
Enable LLDP	Enables the LLDP (Link Layer Discovery Protocol) feature on the phone system. If set to "Yes", the phone system will broadcast LLDP PDU to advertise its identity and capabilities and receive same from a physical adjacent layer 2 peer. The default setting is "Yes".



LLDP TX Inter	Configures the interval the phone sends LLDP-MED packet. Default is 30s.
Enable CDP	Configures whether to enable CDP to receive and/or transmit information from/to CDP-enabled devices. The default setting is "No".
Layer 3 QoS for SIP	Defines the Layer 3 packet's QoS parameter for SIP messages in decimal pattern. This value is used for IP Precedence, Diff-Serv or MPLS. The default setting is 48 which is equivalent to the DSCP name constant CS6.
Layer 3 QoS for Audio	Defines the Layer 3 packet's QoS parameter for RTP messages in decimal pattern. This value is used for IP Precedence, Diff-Serv or MPLS. The default setting is 48 which is equivalent to the DSCP name constant CS6.
Layer 3 QoS for Video	Defines the Layer 3 packet's QoS parameters for H.264 messages in decimal pattern. This value is used for IP Precedence, Diff-Serv or MPLS. The default setting is 48 which is equivalent to the DSCP name constant CS6.
Layer 2 QoS 802.1Q/VLAN Tag (Ethernet)	Assigns the VLAN Tag of the Layer 2 QoS packets for Ethernet. The Default value is 0.
Layer 2 QoS 802.1p Priority Value (Ethernet)	Assigns the priority value of the Layer 2 QoS packets for Ethernet. The Default value is 0.
Layer 2 QoS 802.1Q/VLAN Tag (Wi-Fi)	Assigns the VLAN Tag of the Layer 2 QoS packets for Wi-Fi. The Default value is 0.
Layer 2 QoS 802.1p Priority Value (Wi-Fi)	Assigns the priority value of the Layer 2 QoS packets for Wi-Fi. The Default value is 0.
PC Port VLAN Tag	Defines the VLAN Identifier of the Layer 2 frame for PC port. This tags the VLAN tag value on the target address received from the LAN port of the phone then sends the value to the device connected to the PC port. Note: VLAN tag value on the device connected to the PC port should be the same as the VLAN tag value assigned to the PC port here.
PC Port Priority Value	Determines the Priority Code Point within a Layer 2 frame header for PC port.
PC Port Mode	Enables and defines the PC port mode. If it is set to "Mirrored", the traffic in the LAN port will go through PC port as well and packets can be captured by connecting a PC to the PC port. The default setting is "Enabled".
HTTP/HTTPS User-Agent	Sets the user-agent for phonebook and screen saver.
SIP User-Agent	Sets the user-agent for SIP.



802.1x mode	Enables and selects the 802.1x mode for the phone system. The supported 802.1x modes are the following, the default setting is "Disable": <ul style="list-style-type: none"> • EAP-MD5 • EAP-TLS • EAP-PEAP
802.1x Identity	Enters the identity information for the selected 802.1x mode. (This setting will be displayed only if 802.1 X mode is enabled).
802.1x Secret	Enters the secret for the 802.1x mode. This option will appear when 802.1x mode is EAP-MD5 or EAP-PEAP.
802.1x Private Key Password	Enters the password for the selected 802.1x mode. (This setting will be displayed only if the 802.1 X mode is enabled).
CA Certificate	Uploads the CA Certificate file to the phone. (This setting will be displayed only if the 802.1 X mode is enabled)
Client Certificate	Loads the Client Certificate file to the phone. (This setting will be displayed only if the 802.1 X TLS mode is enabled)
Private Key	Loads the private key file to the phone. (This setting will be displayed only if the 802.1 X TLS mode is enabled)
HTTP/HTTPS Proxy Hostname	Configures the HTTP/HTTPS proxy URI of the network. Some of networks requires to go through a proxy to access to the Internet. The default setting is keeping this field blank.
HTTP/HTTPS Proxy Port	Configures the HTTP/HTTPS proxy port number of the network. Some of networks requires to go through a proxy to access to the Internet. The default setting is keeping this field blank.
Bypass Proxy For	Defines the specific URI that the phone can directly access to without HTTP/HTTPS proxy. If it is filled, the phone will bypass the proxy to send the packets to the specific URI. Default setting is keeping this filed blank.
IPv6 Address	Specify whether to set IPv6 Statically or auto configured.
Static IPv6 Address	When selecting Statically configured IPv6, user need to set the IPv6 address on this field.
IPv6 Prefix length	Specify the Prefix length of the IPv6 address.
DNS Server 1	Configures the primary DNS IPv6 address if IPv6 is statically configured.
DNS Server 2	Configures the secondary DNS IPv6 address if IPv6 is statically configured.
Preferred DNS Server	Set the Preferred DNS IPv6 URL.



Maintenance/Wi-Fi Settings

Wi-Fi Basics	
Wi-Fi Function	Enables/disables the Wi-Fi feature. The default setting is "Disable".
ESSID	Permits to scan and select the available Wi-Fi networks within the range if the Wi-Fi feature is enabled. Click on "Select" to select the Wi-Fi network to connect to. The ESSID will be auto filled in the ESSID field.
Wi-Fi Security	
ESSID	Determines the ESSID of the selected Wi-Fi network. It can be auto filled by clicking the select button on the web page.
Password	Determines the password for the selected Wi-Fi network.
Security Mode for Hidden SSID	Defines the security mode used for the wireless network when the SSID is hidden. Default settings is "None".

Maintenance/Time Settings

Assign NTP Server Address	Defines the URL or IP address of the NTP server. The phone may obtain the current date and time information from the server. The default setting is "pool.ntp.org".
DHCP Option 42 override NTP server	Obtains NTP server address from a DHCP server using DHCP Option 42; it will override configured NTP Server. If set to "No", the phone will use configured NTP server to synchronize time and date even if a NTP server is provided by DHCP server. The default setting is "Yes".
DHCP Option 2 to Override Time Zone setting	Obtains time zone setting (offset) from a DHCP server using DHCP Option 2; it will override selected time zone. If set to "No", the phone will use selected time zone even if provided by DHCP server. The default setting is "Yes".
Time Zone	Specifies the local time zone for the phone. It covers the global time zones and user can selected the specific one from the drop-down list.
Time Display Format	Specifies which format will be used to display the time. It can be selected from 12 hours and 24 hour format.
Date Display Format	Determines which format will be used to display the date. It can be selected from the drop-down list. <ul style="list-style-type: none"> • Normal (M/DD/YYYY): 1/31/2012 • YYYY/MM/DD: 2012/01/31 • MM/DD/YYYY: 01/31/2012 • DD/MM/YYYY: 31/01/2012 The default setting is MM/DD/YYYY.



Maintenance/Web/SSH Access

Disable SSH	Blocks any SSH access to the phone. The default setting is "No".
Disable Web GUI	The phone will not allow any web access to the phone set to "Yes". The default value is "No".
Access Method	Determines which protocol will be used to access the phone 's Web GUI. It can be selected from HTTP and HTTPS. The default setting is HTTP.
Port	Specifies which port will be used to access the phone 's Web GUI. By default, if HTTP is selected, the port number will be 80; if HTTPS is selected, the port number will be 443.
Admin Password	Configures the administrator password for Web GUI. It is case sensitive with a maximum length of 32 characters. The default password is "admin".
Confirm Admin PWD	Confirms the new admin password.
User Password	Configures the user password for Web GUI. It is case sensitive with a maximum length of 32 characters. The default password is "123".
Confirm User Password	Confirms the new admin password.

Maintenance/Upgrade

Firmware Upgrade Via	Allows users to choose the firmware upgrade method: TFTP, HTTP, HTTPS or Manual Upload. The default setting is "HTTP".
Firmware Server Path	<p>Sets IP address or domain name of firmware server.</p> <p>The URL of the server that hosts the firmware release. Setting variables on the server path is also supported, When the phone initiates the firmware request, the device should automatically replace the variable between "%" with the actual value. Default is fm.grandstream.com/gs.</p> <p>Supported Variable:</p> <ul style="list-style-type: none"> • PN • MAC • HWVER • SWVER • HWMODEL
Firmware Upgrade Via	Allows users to choose the firmware upgrade method: TFTP, HTTP, HTTPS or Manual Upload. The default setting is "HTTP".
Firmware Server Path	<p>Sets IP address or domain name of firmware server.</p> <p>The URL of the server that hosts the firmware release. Setting variables on the server path is also supported, When the phone initiates the firmware request, the device should automatically replace the variable between "%" with the actual value. Default is fm.grandstream.com/gs.</p> <p>Supported Variable:</p> <ul style="list-style-type: none"> • PN



	<ul style="list-style-type: none"> • MAC • HWVER • SWVER • HWMODEL
Firmware HTTP/HTTPS User Name	Enters the user name for the firmware HTTP/HTTPS server.
Firmware HTTP/HTTPS Password	Enters the password for the firmware HTTP/HTTPS server.
Firmware File Prefix	Checks if firmware file is with matching prefix before downloading it. This field enables user to store different versions of firmware files in one directory on the firmware server.
Firmware File Postfix	Checks if firmware file is with matching postfix before downloading it. This field enables user to store different versions of firmware files in one directory on the firmware server.
Use Grandstream GAPS	When checked GAPS server will be used for provisioning redirection.
Config Upgrade Via	Selects provisioning method: TFTP, HTTP or HTTPS. Default setting is "HTTPS".
Config Server Path	<p>Sets IP address or domain name of configuration server. The server hosts a copy of the configuration file to be installed on the phone.</p> <p>Setting variables on the server path is also supported, When the phone initiates the provisioning request, the device should automatically replace the variable between "%" with the actual value. Default is fm.grandstream.com/gs. Supported Variable:</p> <ul style="list-style-type: none"> • PN • MAC • HWVER • SWVER • HWMODEL
Config HTTP/HTTPS User Name	Configures the user name for the config HTTP/HTTPS server.
Config HTTP/HTTPS Password	Configures the password for the config HTTP/HTTPS server.
Config File Prefix	Checks if configuration files are with matching prefix before downloading them. This field enables user to store different configuration files in one directory on the provisioning server.
Config File Postfix	<p>Checks if configuration files are with matching postfix before downloading them.</p> <p>This field enables user to store different configuration files in one directory on the provisioning server.</p>



Authenticate Conf File	Sets the phone system to authenticate configuration file before applying it. When set to “Yes”, the configuration file must include value P1 with phone system’s administration password. If it is missed or does not match the password, the phone system will not apply it. Default setting is “No”.
XML Config File Password	Decrypts XML configuration file when encrypted. The password used for encrypting the XML configuration file is using OpenSSL.
Download Device Configuration	Downloads the phone's configuration file in text format. The config file includes all the P value parameters for phone's current settings except password for security purpose. Users can use the Grandstream configuration file generator to generate binary config file from this text file.
Upload Device Configuration	Uploads configuration file to the phone. Note: The GXV3240 supports only txt format for config file upload.
GUI customization file download mode	Selects download method: TFTP, HTTP or HTTPS. Default setting is “HTTP”.
GUI customization file URL	Sets IP address or domain name of the GUI customization file server. The server hosts a copy of the file to be installed on the phone. The Default setting is fm.grandstream.com/gs .
GUI customization file HTTP/HTTPS username	Enters the username for the firmware HTTP/HTTPS server.
GUI customization file HTTP/HTTPS password	Enters the password for the firmware HTTP/HTTPS server.
Use Configurations of Config File Server	Retrieve and download customization file with the configuration of the config file.
Configuration via Keypad Menu	Configures access control for keypad Menu settings on the Settings interface of the phone. <ul style="list-style-type: none"> • Unrestricted: configure all settings on the Settings interface; • Basic Settings Only: The Advanced Settings option will not be displayed; • Basic Settings & Network Settings: Only the Advanced Settings option will not be displayed; (Bluetooth/Wi-Fi/Ethernet Settings are still open to use) • Constraint Mode: users need to input admin user password to configure Wireless & Network and Advanced Settings. Note: When access control for keypad is limited to “Basic Settings Only” or “Constraint Mode”, the Admin authentication will be mandatory to start Factory Reset process.
Always send HTTP Basic Authentication Information	Includes configured username and password in HTTP request before receiving authentication challenge from the server. Default is “No”.



Validate Certification Chain	Configures whether to validate the server certificate when download the firmware/config file. If it is set to "Yes", the phone will download the firmware/config file only from the legitimate server. Default setting is "No".
mDNS Override Server	Sets the phone system to broadcast the Multicast DNS (mDNS) message during booting up to allow itself to be discovered and be configured by the SIP platform. If it is set to "User Type A", the phone system will broadcast the MDNS message "A_grandstream-cfg.local"; if it is set to "Use Type SRV", the MDNS message will be "SRV_grandstream-cfg.local". The default setting is "Use Type A".
Allow DHCP Option 43 and Option 66 to Override Server	Obtains configuration and upgrade server's information from DHCP server using options 66 and 43. Note: If DHCP Option 66 is enabled, the phone will attempt downloading the firmware file from the server URL provided by DHCP, even though Config Server Path is left blank. The default setting is "Yes".
DHCP Option 120 Override SIP Server	Configures the phone system to allow the DHCP offer message to override the Config Server Path via the Option 120 header. Default setting is "Yes".
Allow DHCP Option 242 (Avaya IP Phones)	Enables DHCP Option 242. Once enabled, the phone will use the configuration info issued by the local DHCP in Option 242 to configure proxy, transport protocol and server path. The default setting is "Yes".
Enable PNP Feature	Enables the PNP (Plug and Play) feature on the device. If it is enabled, the device will be set as a provision server to send SIP NOTIFY message including the provision URL to response the client phone's SIP SUBSCRIBE request. This feature will be enabled if the PNP URL is configured. If this setting is enabled, the 3CX Auto provision will be disabled automatically.
PNP URL	Configures the URL to provision other client phone's config server path. The URL will be included in the SIP NOTIFY message.
PnP(3CX) Auto Provision	Sets the phone system to broadcast the SIP SUBSCRIBE message during booting up to allow itself to be discovered and be configured by the SIP platform. The default setting is "Yes".
Automatic Upgrade	Specifies when the firmware upgrade process will be initiated; there are 4 options. The default setting is "No". <ul style="list-style-type: none"> • No: The phone will only do upgrade once at boot up. • Check every X minutes: User needs to specify a period in minutes. • Check every day: User needs to specify "Hour of the day (0-23)". • Check every week: User needs to specify "Hour of the day (0-23)" and "Day of the week (0-6)". • Check at a period Time: User needs to specify "Hour of the day (0-23)" Note: Day of week is starting from Sunday. The default setting is No.



Enable Randomized Automatic Upgrade	Configures how the GXV3240 will check the server for new firmware and configuration file downloading. It only valid if the user selects “Check at a period of time” in the “Automatic Upgrade”. If enabled, GXV3240 upgrade automatically at random time point in the setting period. This option is mainly used for multiple devices upgrade at the same time
Automatic Upgrade Check Interval (m)	Configures how the phone system will check the server for new firmware and configuration file downloading. It only valid if the user selects “Check at a period of time” in the “Automatic Upgrade”. The default setting is 10080 (namely 7 days).
Hour of the Day (0-23)	Defines at which hour of the day they phone system will check the HTTP/HTTPS/TFTP server for firmware upgrades or configuration files changes.
Day of the Week (0-6)	Defines which day of the week the phone system will check the HTTP/HTTPS/TFTP server for firmware upgrades or configuration files changes.
Firmware Upgrade and Provisioning	Defines the phone system’s rules for automatic upgrade. It can be selected from: <ul style="list-style-type: none"> • Always Check at bootup • Always Check at bootup, when F/W pre/suffix changes, • Skip the Firmware Check. The default setting is “Always Check at bootup”.
Disable SIP NOTIFY Authentication	Disables the SIP NOTIFY Authentication on the phone. If set to “Yes”, the phone will not challenge NOTIFY with 401. The default setting is “No”.
Auto Reboot to Upgrade Without Prompt	Configures the phone system to pop up a notification message before upgrading new firmware. If set to "Yes", the phone will automatically start upgrading after downloading the firmware file. Otherwise, users would need to confirm in the prompted message on the LCD screen to start upgrading process. The default setting is "Yes".
Factory Reset	Resets the phone system to the default factory setting mode. If the “Clear the SD card” is checked, the SD card storage mounted on the phone will be format as well.

Maintenance/Syslog

Syslog Protocol	Select the transport protocol over which log messages will be carried. <ul style="list-style-type: none"> • UDP: Syslog messages will be sent over UDP. • SSL/TLS: Syslog messages will be sent securely over TLS connection. To upload server CA certificate follow below steps: <ul style="list-style-type: none"> ✓ Copy CA file in SD card and plug it to the phone. ✓ Go to LCD menu Settings→Security Settings→Install from SD card to install the CA file.
------------------------	---



Syslog Server	Configures the URI which the phone system will send the syslog messages to. The default setting is "log.ipvideotalk.com".
Syslog Level	<p>Selects the level of logging for syslog. The default setting is "None". There are 4 levels from the dropdown list: NONE, DEBUG, INFO, WARNING and ERROR. The following information will be included in the syslog packet:</p> <ul style="list-style-type: none"> • DEBUG (Sent or received SIP messages) • INFO (Product model/version on boot up, NAT related info, SIP message summary, Inbound and outbound calls, Registration status change, negotiated codec, Ethernet link up) • WARNING (SLIC chip exception) • ERROR (SLIC chip exception, Memory exception) <p>Note: Changing syslog level does not require a reboot to take effect.</p>
Syslog Keyword Filter	Only send the syslog with keyword, multiple keywords are separated by comma. Example: set the filter keyword to "SIP" to filter SIP log.

Maintenance/Logcat

Clear Log	Clears the log files saved in the phone system.
Log Tag	Configures the filter to display the specified process log file.
Log Priority	<p>Selects the log priority to display. It can be selected from:</p> <ul style="list-style-type: none"> • Verbose • Debug • Info • Warn • Error • Fatal • Silent (suppress all output). <p>The default setting is "Verbose".</p>
Get Log	Displays the log file on the web page.

Maintenance/Debug

Capture Trace	Press START to start capturing a trace, and press STOP to stop the capture process.
Trace List	Lists the captured files in the drop-down box. Click the "Delete" button to delete the selected trace.
View Trace	<p>Enters phone system's directory to view the captured trace files from the web browser. In the directory, click on the name of the file to download it.</p> <p>Note: The trace files are saved in phone's internal storage. Users can access or delete the trace files from LCD→FileManager→Internal Storage→ppp directory.</p>



Record	Allows user to start capturing audio. User can record up to 1-minute audio data.
Recording List	List of already recorded audios. "Delete" button to delete recorded files.
View Recording	"List" button used to view the captured audio. Once clicked the captured audio will be sorted by time. Note: The audio data file will be saved under FileManager → Internal Storage → Recfiles folder. Users can also delete files under this folder.
Enable Core Dump Generation	Configures whether to generate and save the core dump file when the program crashes. The default setting is "No".
Core Dump List	Selects the existing core dump file in the drop-down box. Users could delete the file by pressing on "Delete" button.
View Core Dump	Press "List" button to view all existing core dump files. The files are listed in chronological order, users could click the file name to download the file to the local computer.
Clear Log	Click "Clear" to clear old logs.
Download Log	This feature allows user to download the log in device. After some troubleshooting, click "Download" to save the files in local storage.

Maintenance/Language

Language	Sets the language to display on the phone's LCD (English, German, Italian, French, Spanish, Portuguese, Russian, Croatian, Dutch, Chinese, Korean, Japanese, and more)
-----------------	--

Maintenance/Event Notification

Set the URL for events on phone web GUI, and when the corresponding event occurs on the phone, the phone will send the configured URL to SIP server. The dynamic variables in the URL will be replaced by the actual values of the phone before sending to SIP server, in order to achieve the purpose of events notification. Here are the standards:

1. The IP address of the SIP server needs to be added at the beginning, and separate the dynamic variables with a "/".
2. The dynamic variables need to have a "\$" at the beginning. For example: local=\$local.
3. If users need to add multiple dynamic variables in the same event, users could use "&" to connect with different dynamic variables.
For example: 192.168.40.207/mac=\$mac&local=\$local
4. When the corresponding event occurs on the phone, the phone will send the MAC address and phone number to server address 192.168.40.207.

On Boot Completed	Configures the event URL when phone boots up.
Incoming Call	Configures the event URL when phone has an incoming call.



Outgoing Call	Configures the event URL when phone has an outgoing call.
On Off-hook	Configures the event URL when the phone is off-hook.
On On-hook	Configures the event URL when the phone is on-hook.
Missed Call	Configures the event URL when the phone has new a missed call.
On Connected	Configures the event URL when a call is established.
On Disconnected	Configures the event URL when a call is disconnected.
DND On	Configures the event URL when DND is enabled.
DND Off	Configures the event URL when DND is disabled.
Forward On	Configures the event URL when the forward feature is enabled on the phone.
Forward Off	Configures the event URL when the forward feature is disabled on the phone.
On Blind Transfer	Configures the event URL when users transfer a call with blind transfer on the phone.
On Attended Transfer	Configures the event URL when users transfer a call with attended transfer on the phone.
On Hold	Configures the event URL when users hold a call on the phone.
On UnHold	Configures the event URL when users resume a call on the phone.
Log On	Configures the event URL when users log on the phone successfully.
Log Off	Configures the event URL when users log off the phone.
On Register	Configures the event URL when an account is registered successfully.
On Unregister	Configures the event URL when an account in the phone is unregistered.

Maintenance/TR-069

Enable TR-069	Sets the phone system to enable the “CPE WAN Management Protocol” (TR-069). The default setting is “No”.
ACS URL	Specifies URL of TR-069 ACS (e.g., http://acs.mycompany.com), or IP address.
ACS Username	Enters username to authenticate to ACS.
ACS Password	Enters password to authenticate to ACS.
Periodic Inform Enable	Sends periodic inform packets to ACS. Default is “No”.
Periodic Inform Interval (s)	Configures to sends periodic “Inform” packets to ACS based on specified interval.
Connection Request Username	Enters user name for the ACS to connect to the phone.
Connection Request Password	Enters password for the ACS to connect to the phone.



Connection Request Port	Enters the port for the ACS to connect to the phone.
CPE Cert File	Uploads Cert File for the phone to connect to the ACS via SSL.
CPE Cert Key	Uploads Cert Key for the phone to connect to the ACS via SSL.

Maintenance/Contacts

Sort Phonebook by	Sets which part of name, first name or last name, will be sorted in alphabetical order to display.
Phonebook Key Function	<p>Controls the behaviors of the phonebook key. It could be set to:</p> <ul style="list-style-type: none"> • Default • LDAP Search • Local Phonebook • Local Group • BroadSoft Phonebook <p>The default setting is "Default", which set the phonebook key to the Contacts menu.</p>
Emergency Call Numbers	Configures the emergency contact in logout mode. If the system is logout, guest users can dial the configured emergency contacts. Input the number in the input box and click "Add" to add the number to the contacts list. To delete the existing ICE number, select the number in the contacts list and click "Delete".

Import/Export

File Encoding	<p>Specifies the encoding format for phonebook file importing or exporting. It can be selected from the dropdown list (The default setting is UTF-8):</p> <ul style="list-style-type: none"> • UTF-8 • GBK • UTF-16 • UTF-32 • Big5 • Big5-HKSCS • Shift-JIS • ISO8859-1 • ISO8859-15 • Windows-1251 • EUC-KR
File Type	<p>Sets the type format for phonebook file importing or exporting. It can be selected from the dropdown list: The default setting is "XML".</p> <ul style="list-style-type: none"> • XML • VCard • CSV



Save Phonebook to PC	Downloads the phonebook file from the phone system to PC.
Clear The Old List	Determines if the phone system will delete the previous contacts when a new contact file is imported. If set to "Yes", the previous contacts will be removed. The default setting is "No".
Replace Duplicate Items	Configures the phone system to keep the original contact entries when duplicated contact entries are included in the contact file. If set to "Yes", the phone will replace the original entries to the new one. Otherwise, the phone system will save both contact entries. The default setting is "No".
Local File	Uploads the contact files from PC to the phone system.
Download (XML Phonebook)	
Clear The Old List	Sets the phone to delete the previous contacts when a new contact file is downloaded if set to "Yes". The default setting is "No".
Replace Duplicate Items	Keeps original contact entries when duplicated contact entries are included in the contact file. If set to "Yes", the phone will replace the original entries to the new one. Otherwise, the phone system will save both contact entries. Default is "No".
Download Mode	Enables the phone system to download phonebook file and select the server and protocol to download the phonebook file. It can be selected from TFTP, HTTP, and HTTPS. The default setting is "OFF".
File Encoding	Selects the encoding format for phonebook file download. It can be selected from the dropdown list (The default setting is UTF-8): <ul style="list-style-type: none"> • UTF-8 • GBK • UTF-16 • UTF-32 • Big5 • Big5-HKSCS • Shift-JIS • ISO8859-1 • ISO8859-15 • Windows-1251 • EUC-KR
Download Server	Configures the server URI to download the phonebook file. The phone system will send a request to the server to download the phonebook file with filename phonebook.xml .
HTTP/HTTPS User Name	Configures user name for HTTP/HTTPS server to download the phonebook file.
HTTP/HTTPS Password	Specifies password for HTTP/HTTPS server to download phonebook file.
Download Now	Starts downloading the XML phonebook to the phone immediately.



Download Interval	<p>Determines how the phone system to send the request to the server to download the phonebook file.</p> <p>It can be selected from the dropdown list:</p> <ul style="list-style-type: none"> • None • 2 Hour • 4 Hour • 6 Hour • 8 Hour • 12 Hour
--------------------------	--

 **Note:**

For more information on XML Based Downloadable Phonebook on GXV3240, please refer to the GXV3240 XML Phonebook Guide in the following link:

http://www.grandstream.com/sites/default/files/Resources/gxv3240_xml_phonebook_guide_1.pdf

Maintenance/LDAP Book

Connection Mode	Selects which protocol will be used for LDAP searching, LDAP or LDAPS.
Server Address	Configures the URI of the LDAP (Lightweight Directory Access Protocol) server.
Port	Configures the LDAP server port. The default LDAP port number is 389.
Base DN	<p>Determines the LDAP search base. This is the location in the directory where the search is requested to begin.</p> <p><u>Example:</u> dc=grandstream, dc=com ou=Boston, dc=grandstream, dc=com</p>
User Name	Configures the bind "Username" for querying LDAP servers. Some LDAP servers allow anonymous binds in which case the setting can be left blank.
Password	Specifies the bind "Password" for querying LDAP servers. The field can be left blank if the LDAP server allows anonymous binds.
LDAP Name Attributes	<p>Configures the "name" attributes of each record which are returned in the LDAP search result. This field allows the users to configure multiple space separated name attributes.</p> <p><u>Example:</u> gn cn sn description</p>
LDAP Number Attributes	Configures the "number" attributes of each record which are returned in the LDAP search result. This field allows the users to configure multiple space



	<p>separated number attributes.</p> <p><u>Example:</u> telephoneNumber telephoneNumber Mobile</p>
LDAP Mail Attributes	<p>Determines the "mail" attributes of each record which are returned in the LDAP search result.</p> <p><u>Example:</u> mail</p>
LDAP Name Filter	<p>Configures the filter used for name lookups.</p> <p><u>Examples:</u> ((cn=%)(sn=%)) returns all records which has the "cn" or "sn" field starting with the entered prefix; (!(sn=%)) returns all the records which do not have the "sn" field starting with the entered prefix; (&(cn=%) (telephoneNumber=*)) returns all the records with the "cn" field starting with the entered prefix and "telephoneNumber" field set.</p>
LDAP Number Filter	<p>Defines the filter used for number lookups.</p> <p><u>Examples:</u> ((telephoneNumber=%)(Mobile=%) returns all records which has the "telephoneNumber" or "Mobile" field starting with the entered prefix; (&(telephoneNumber=%) (cn=*)) returns all the records with the "telephoneNumber" field starting with the entered prefix and "cn" field set.</p>
LDAP Mail Filter	<p>Determines the filter used for mail lookups.</p> <p><u>Example:</u> (mail=%)</p>
LDAP Displaying Name Attributes	<p>Configures the entry information to be shown on phone's LCD. Up to 3 fields can be displayed.</p> <p><u>Example:</u> %cn %sn %telephoneNumber</p>
Max Hits	<p>Specifies the maximum number of results to be returned by the LDAP server. If set to 0, server will return all search results. Default setting is 50.</p>
Search Timeout (ms)	<p>Configures the interval (in seconds) for the server to process the request and client waits for server to return. The default setting is 4000 seconds.</p>
LDAP Lookup For Dial	<p>Sets the phone system to do the LDAP number searching when making outgoing calls. The default setting is "No".</p>
LDAP Lookup For Incoming Call	<p>Sets the phone system to do LDAP number searching for incoming calls. The default setting is "No".</p>
LDAP Dialing Default Account	<p>Configures the default account that being used when dialing LDAP contact. Users may choose the Account 1-6, the default setting is "Default".</p>



 **Note:** For more information on how to configure LDAP on GXV3240, please refer to the GXV3240 LDAP Configuration Guide in the following link:
http://www.grandstream.com/sites/default/files/Resources/gxv3240_ldap_book_guide.pdf

Maintenance/Broadsoft Directories

Authentication Type	Defines the authentication type in way of login or use SIP. If set to "Login Credentials", please fill in Username and Password in the following options; if set to "SIP Credentials", please fill in Username, User ID, and Password. The default setting is "SIP Credentials".
Server	Configures BroadWorks Xsi server URI. If the server uses HTTPS, please add the header "HTTPS" ahead of the Server URI. For instance, "https://SERVER_URI".
Port	Configures the BroadWorks Xsi server port. The default port is 80. If the server uses HTTPS, please configure 443.
Action Path	Configures the action path for Broadsoft XSI server.
BroadWorks User ID	Determines the User ID for BroadWorks XSI server.
SIP Authentication ID	Configures the Username for Broadsoft XSI server.
SIP Auth Password	Configures the Password for Broadsoft XSI server.
Login Password	Specifies the password for the BroadWorks Xsi query.
Group Directory	Enables/disables BroadWorks Xsi Group Directory features on the phone. The name filed is used to name the directory. If it keeps blank, the phone system will use the default name "Group" for it.
Enterprise Directory	Enables/disables the BroadWorks Xsi Enterprise Directory features on the phone. The name filed is used to name the directory. If it keeps blank, the phone system will use the default name "Enterprise" for it.
Group Common	Enables/disables the BroadWorks Xsi Group Common features on the phone. The name filed is used to name the directory. If it keeps blank, the phone system will use the default name "Group Common" for it.
Enterprise Common	Enables/disables the BroadWorks Xsi Enterprise Common features on the phone. The name filed is used to name the directory. If it keeps blank, the phone system will use the default name "Enterprise Common" for it.
Personal Directory	Enables/disables the BroadWorks Xsi Personal Directory features on the phone. The name filed is used to name the directory. If it keeps blank, the phone system will use the default name "Personal Directory" for it.
Polycom Phonebook	Enables/disables the BroadWorks Xsi Polycom Phonebook features on the phone. The name filed is used to name the directory. If it keeps blank, the phone system will use the default name "Polycom Phonebook" for it.



Missed Call Log	Enables/disables the BroadWorks Xsi Missed Call Log features on the phone. The name filed is used to name the directory. If it keeps blank, the phone system will use the default name “Missed” for it.
Placed Call Log	Enables/disables the BroadWorks Xsi Placed Call Log features on the phone. The name filed used to name the directory. If it keeps blank, the phone system will use the default name “Outgoing” for it.
Received Call Log	Enables/disables the BroadWorks Xsi Received Call Log features on the phone. The name filed used to name the directory. If it keeps blank, the phone system will use the default name “Incoming” for it.
BroadSoft Directory & Call Logs Update Interval (s)	Specifies how often the phone system sends HTTP/HTTPS query to the BroadWorks Xsp server to update the BroadWorks Call History. The default setting is 1800 seconds.
BroadSoft Directory Hits	Determines how many entry results will be showed in each query. If it is configured, the phone system will add the header to the HTTP query. The valid range is from 1 to 1000. The default setting is blank, which means to use the server's default value.
BroadSoft Directory Order	Configures the BS contact order on the LCD. The order of contact categories on the Web GUI from top to bottom is same as the order from left to right on the BS contact app. Select one item and click the Up/Down arrow on the right to adjust the order.

Maintenance/Broadsoft IM&P

Server	Configures the BroadSoft XMPP server URI.
Port	Specifies the BroadSoft XMPP server port. The default port is 5222.
Username	Determines the Username for the BroadSoft XMPP query.
Password	Determines the password for the BroadSoft XMPP query.
Enable BroadSoft IM&P	Enables the BroadSoft XMPP feature.
Associated BroadSoft Account	Binds the SIP account for dialing the XMPP client contacts.
Auto Login	Sets the client to be logged automatically if the application is started.
Display Non XMPP Contacts	Determines if the client app will show the non-XMPP contacts.

Maintenance/Device Manager

HDMI Control	Enables the HDMI output and selects the HDMI mode if it is activated. It can be selected from the dropdown list. <ul style="list-style-type: none"> • Disabled: The phone system will shut down the HDMI port. • Mirrored: The connected HDMI device will mirror the LCD display.
---------------------	---



	<ul style="list-style-type: none"> • Remote Video: The connected HDMI device will play the remote party's video during a video call. The rest displays are mirror the LCD screen. <p>The default setting is "HDMI Display Synchronization with LCD".</p>
AE Mode	<p>Selects AE mode (Automatic Exposure). AE mode has two options "Dark Environment" and "Bright Environment". Users could select the mode according to the actual environment (dark or bright) where the camera is being used. The phone's camera settings including exposure, brightness, contrast and Gamma value will be automatically adjusted to achieve better visual effect under the selected environment. The default setting is "Bright Environment".</p>
Disable Missed Call Backlight	<p>Keeps LCD screen turned on after screen timeout when there is unchecked missed call on the phone if set to "Yes". Default setting is "No".</p>
Disable Missed Call Indicator	<p>Turns off the LCD backlight when there are new missed call logs on the phone. If it set to "Yes", the LCD backlight will be turned off if the phone system has new missed call log. Otherwise, the LCD backlight will keep on. The Default setting is "No".</p>
Disable MWI Indicator	<p>Turns on the LED indicator at device's upper right corner when there are unread Voice Mails. If it set to "Yes", the LED indicator will keep off if the phone system receives SIP NOTIFY message about unread voice mail. Otherwise, the LED indicator will be turned on. The default setting is "No".</p>
Disable New Message Indicator	<p>Turns on the LED indicator at device's upper right corner when there are unread Messages. If it set to "Yes", the LED indicator will keep off if the phone system has new messages. Otherwise, the LED indicator will be turned on. The Default is "No".</p>
Disable Contact Full Indicator	<p>Sets the phone system to turn on the LED indicator at device's upper right corner when the internal contact storage or message storage is full. If it set to "Yes", the LED indicator will keep off if the phone system has new messages. Otherwise, the LED indicator will be turned on.</p> <p>The default setting is "No".</p>
Disable Indicator When LCD is Off	<p>If set to "Yes", the LED indicator on the upper right corner of the GXV3240 will not light up when the LCD screen is off. The default setting is "No".</p> <p>It is used to set if the phone system will turn on the LED indicator at device's upper right corner when the LCD screen is turned off. If it set to "Yes", the LED indicator will keep off when the LCD screen is off. Otherwise, the LED indicator will be turned on. The default setting is "No".</p>
RJ9 Headset TX Gain (dB)	<p>Configures the Transmission Gain in RJ9 headset channel. It can be selected from the dropdown list:</p> <ul style="list-style-type: none"> • -24 • -18 • -12



	<ul style="list-style-type: none"> • -6 • 0 • +6 • +12 • +18 • +24 <p>The default setting is 0dB.</p>
RJ9 Headset RX Gain (dB)	<p>Configures the Receive Gain in RJ9 headset channel. It can be selected from the dropdown list:</p> <ul style="list-style-type: none"> • -9 • -6 • 0 • +6 • +9 <p>The default setting is 0dB.</p>
Headset Type	<p>Specifies which type of headset will be connected to the phone system. It can be selected from the dropdown list:</p> <ul style="list-style-type: none"> • Normal Headset • Plantronics EHS <p>If a normal RJ11 headset is connected, it should set to “Normal Headset”. If a Plantronics EHS headset is used, it should set to “Plantronics EHS”.</p>
Headset Key Mode	<p>Defines Headset key mode when headset is connected to the phone; users could use the HEADSET button in two different modes:</p> <ol style="list-style-type: none"> 1. Default Mode <ul style="list-style-type: none"> • When the phone is in idle, press HEADSET button to off-hook the phone and make calls by using headset. Headset icon will display on the top of the call screen in dialing/talking status; • When there is an incoming call, press HEADSET button to pick the call by using headset; • When there is an active call using headset, press HEADSET button to hang up the call; • When Speaker/Handset is used in dialing/talking status, press HEADSET button to switch to headset. Press it again to hang up the call, or press Speaker/Handset to switch back to previous mode. 2. Toggle Headset/Speaker <ul style="list-style-type: none"> • When the phone is in idle, press HEADSET button to switch to Headset mode. The idle screen will display a Headset icon. In this



	<p>mode, if pressing Speaker button or entering digits, headset will be used by default;</p> <ul style="list-style-type: none"> • When there is an incoming call, press Answer icon on the screen or Speaker button, headset will be used; • When there is an active call, press HEADSET button to toggle between Headset and Speaker.
Handset TX Gain (dB)	<p>Configures the transmission gain of the handset.</p> <ul style="list-style-type: none"> • 0 • -6 • +6 <p>The default setting is “-6dB”.</p>
Handset RX Gain (dB)	<p>Configures the handset volume, thus controls the received audio signal.</p> <p>Note: When set to +6dB, the increasing handset volume may cause irreversible damage to the hearing, please proceed with caution.</p> <ul style="list-style-type: none"> • 0 • -6 • +6 <p>The default setting is “0dB”.</p>
Virtual Sound Card TX gain(dB)	<p>Configures the transmission gain of the virtual sound card, it can be selected from the dropdown list:</p> <ul style="list-style-type: none"> • -18 • -15 • -12 • -9 • -6 • -3 • 0 • +3 • +6 • +9 • +12 • +15 • +18 <p>The default setting is 0dB.</p>
Virtual Sound Card RX gain(dB)	<p>Configures the virtual sound card received audio signal, it can be selected from the dropdown list:</p> <ul style="list-style-type: none"> • -18 • -15



	<ul style="list-style-type: none"> • -12 • -9 • -6 • -3 • 0 • +3 • +6 • +9 • +12 • +15 • +18 <p>The default setting is "0dB".</p>
Handset Equalizer RX	<p>Specifies the handset equalizer RX, users could also set to "Gentle" or "Fidelity".</p> <ul style="list-style-type: none"> • Default • Gentle • Fidelity <p>The default setting is "Fidelity".</p>
Disable RJ9 Headset Auto Detect	<p>If set to "Yes", the auto detection on RJ9 will be disabled automatically and users will need to activate the RJ9 headset manually from the LCD screen. The default setting is "No".</p>

Reboot

To reboot remotely your GXV3240, tap on "**Reboot**" button as displayed on following screenshot.



Figure 22: Reboot Button

UPGRADING AND PROVISIONING

The GXV3240 can be upgraded via TFTP/HTTP/HTTPS by configuring the URL/IP Address for the TFTP/HTTP/HTTPS server and selecting a download method. Configure a valid URL for TFTP, HTTP or HTTPS; the server name can be FQDN or IP address.

Examples of valid URLs:

firmware.grandstream.com/BETA

fw.mycompany.com

Upgrade and Provisioning Configuration

There are two ways to setup upgrade and provisioning on GXV3240. They are Keypad Menu and Web GUI.

- **Configure via keypad Menu**

In GXV3240 Settings, select **Advanced Settings**→**Upgrade**. Users may then select the upgrade mode and enter the IP address or FQDN for the Firmware server and the Config server. After making the changes, tap **Save** button to save the change. Then reboot the phone.

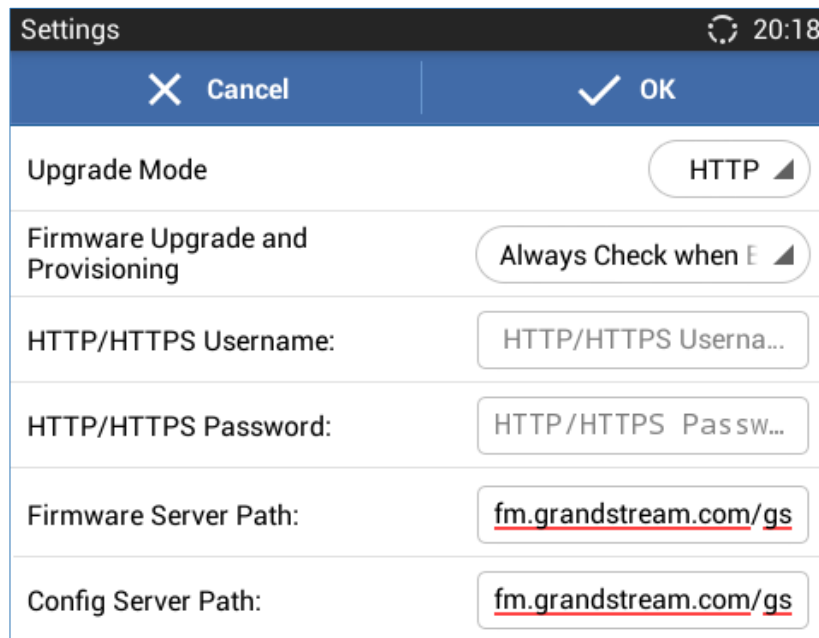

The screenshot shows the 'Settings' screen on a device. At the top right, there is a refresh icon and the time '20:18'. Below the title bar, there are 'Cancel' and 'OK' buttons. The main content area contains several settings:

- Upgrade Mode:** Set to 'HTTP' with a dropdown arrow.
- Firmware Upgrade and Provisioning:** Set to 'Always Check when E' with a dropdown arrow.
- HTTP/HTTPS Username:** Text field containing 'HTTP/HTTPS Userna...'.
- HTTP/HTTPS Password:** Text field containing 'HTTP/HTTPS Passw...'.
- Firmware Server Path:** Text field containing 'fm.grandstream.com/gs'.
- Config Server Path:** Text field containing 'fm.grandstream.com/gs'.

Figure 23: GXV3240 Upgrade Configuration via LCD

- **Configure via Web GUI**

Open a web browser on PC and enter the IP address for the GXV3240. Then login with the administrator username and password. Go to **Maintenance** section, select **Upgrade** tab. In the Upgrade web page, enter the IP address or the FQDN for the upgrade server and choose to upgrade via TFTP, HTTP or HTTPS. Save and apply the changes, then reboot the phone.

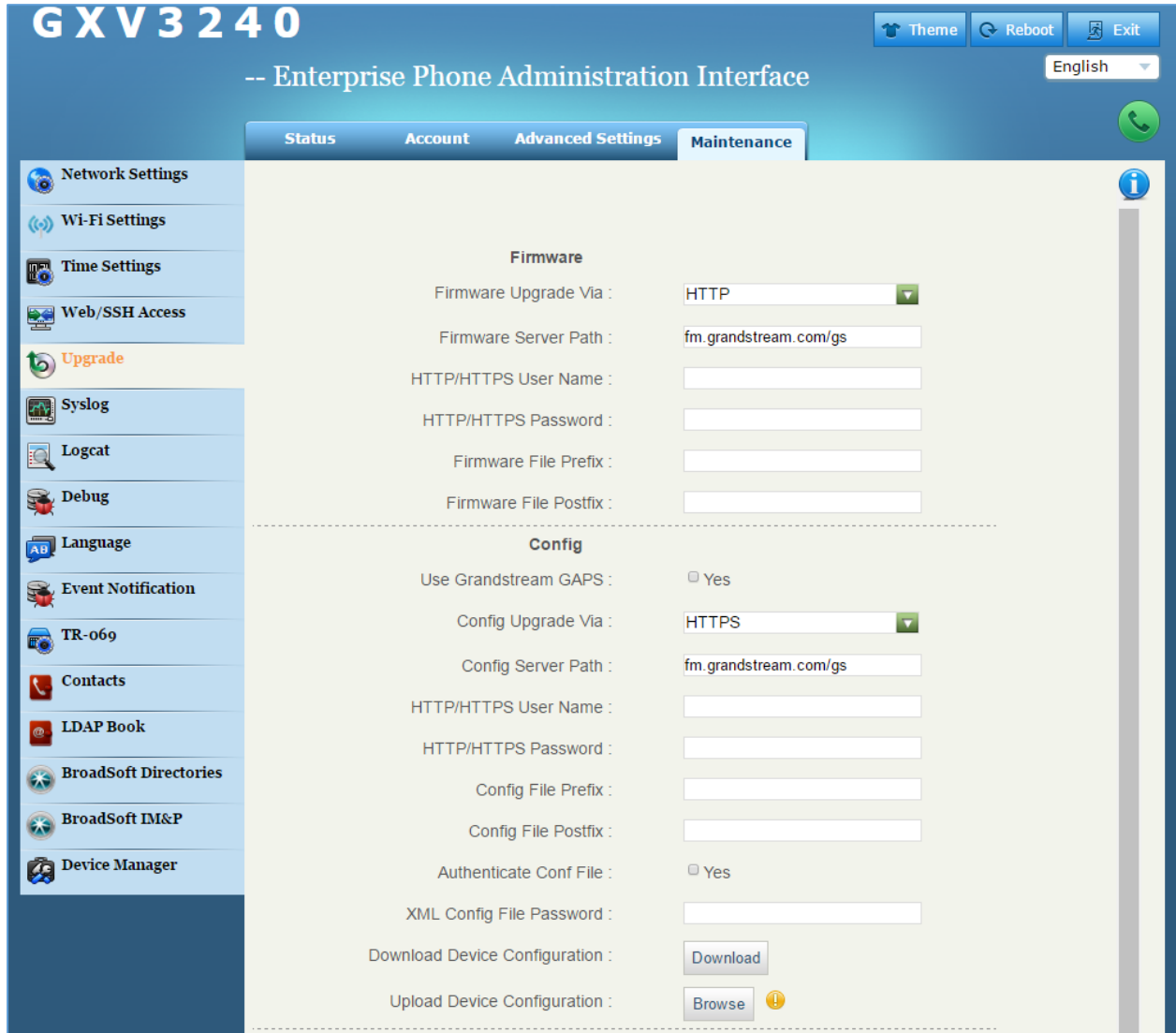

Figure 24: GXV3240 Upgrade Configuration via Web GUI



Note:

- Please do not power off or unplug the GXV3240 when the upgrading process is on.
- The GXV32xx supports SNI (Server Name Indication) TLS extension when using provisioning via HTTPS.
- The provisioning will start without reboot if HTTP/HTTPS username/password are updated.

Upload Firmware Locally

If there is no HTTP/TFTP server, users could also upload the firmware to the GXV3240 directly via Web GUI. Please follow the steps below to upload firmware to GXV3240 locally.

1. Download the latest GXV3240 firmware file from the following link and save it in your PC.

<http://www.grandstream.com/support/firmware>



2. Log in the Web GUI as administrator in the PC.
3. Go to Web GUI→**Maintenance**→**Upgrade**, configure **Upgrade Via** as "Manually Upload".
4. Click the "Upload" button, a window will be prompted to select firmware file to upload.
5. Select the firmware file from your PC. Then uploading progress will show at the button where it was "Upload" in the above step.
6. When uploading is done, users can see the upgrading process starts on the GXV3240 LCD.
7. The phone will reboot again with the new firmware version upgraded.

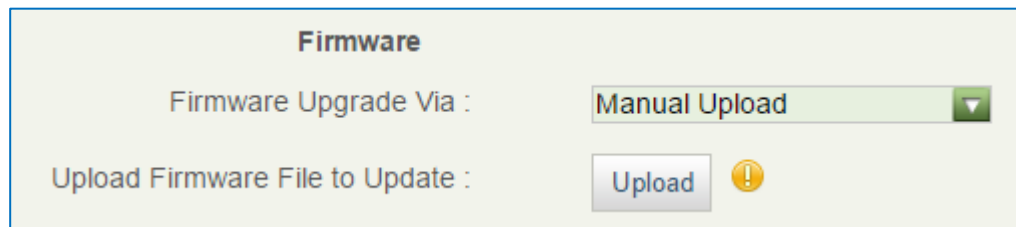

Figure 25: Firmware Upgrade

Note: The previous upgrade notification bar will be removed when doing manual upload upgrading.

Upgrade via SD Card

For users that could not use remote upgrade or could not access the phone's Web GUI to upload firmware, upgrading via external SD card is an alternative. Follow the steps below to upgrade GXV3240 via SD card.

1. Download the firmware file to PC and save it in SD card.
2. Insert the SD card to GXV3240.
3. Power cycle the GXV3240.
4. When the phone starts booting up, press and hold both "*" and "3" keys at the same time for about 5 seconds.
5. The GXV3240 will display the upgrading process in the screen.
6. Wait until the upgrading is done.
7. The GXV3240 will reboot itself.
8. Check the firmware status and remove the SD card.



Note:

- Before upgrading, please ensure your device is using a 12V power adapter.
 - Upgrading via USB storage device is not supported on the GXV3240.
-

No Local Firmware Servers

Service providers should maintain their own firmware upgrade servers. For users who do not have a TFTP/HTTP/HTTPS server, some free Windows version TFTP servers are available for download from:

<http://www.solarwinds.com/free-tools/free-tftp-server> and <http://tftpd32.jounin.net/>.

Please check our web site at <http://www.grandstream.com/support/firmware> for latest firmware.

Instructions for local firmware upgrade via TFTP:

1. Unzip the firmware files and put all of them in the root directory of the TFTP server;
2. Connect the PC running the TFTP server and the GXV3240 device to the same LAN segment;
3. Launch the TFTP server and go to the File menu→Configure→Security to change the TFTP server's default setting from "Receive Only" to "Transmit Only" for the firmware upgrade;
4. Start the TFTP server and configure the TFTP server in the phone's web configuration interface;
5. Configure the Firmware Server Path to the IP address of the PC;
6. Update the changes and reboot the GXV3240.

End users can also choose to download a free HTTP server from <http://httpd.apache.org/> or use Microsoft IIS web server.

Provisioning and Configuration File Download

Grandstream SIP Devices can be configured via the Web Interface as well as via a Configuration File (binary or XML) through TFTP or HTTP/HTTPS. The "Config Server Path" is the TFTP, HTTP or HTTPS server path for the configuration file. It needs to be set to a valid URL, either in FQDN or IP address format. The "Config Server Path" can be the same or different from the "Firmware Server Path".

A configuration parameter is associated with each particular field in the web configuration page. A parameter consists of a Capital letter P and 2 to 3 (Could be extended to 4 in the future) digit numeric numbers. i.e., P2 is associated with the "Admin Password" in the Web GUI→**Maintenance**→**Web/SSH Access** page. For a detailed parameter list, please refer to the corresponding firmware release configuration template in the following link:

<http://www.grandstream.com/support/tools>

When the GXV3240 boots up, it will issue TFTP or HTTP request to download a configuration XML file named "cfgxxxxxxxxxxxx" followed by "cfgxxxxxxxxxxxx.xml", where "xxxxxxxxxxxx" is the MAC address of the phone, i.e., "cfg000b820102ab" and "cfg000b820102ab.xml". If downloading "cfgxxxxxxxxxxxx.xml" file is not successful, the provision program will download a generic cfg.xml file. The configuration file name should be in lower case letters.

For more details on XML provisioning, please refer to the following document:

http://www.grandstream.com/sites/default/files/Resources/gs_provisioning_guide.pdf



BACKUP

The following data on the GXV3240 can be backed up and restored to the phone again using the built-in

Backup application .

- **System applications:** Blacklist, Contacts, Call history, Config, SMS, Calendar and desktop settings
- **Third party applications**

Generate Backup File

1. Open Backup application by tapping on icon  from phone's menu or desktop.
2. A list the previous backup files will be displayed (if any).

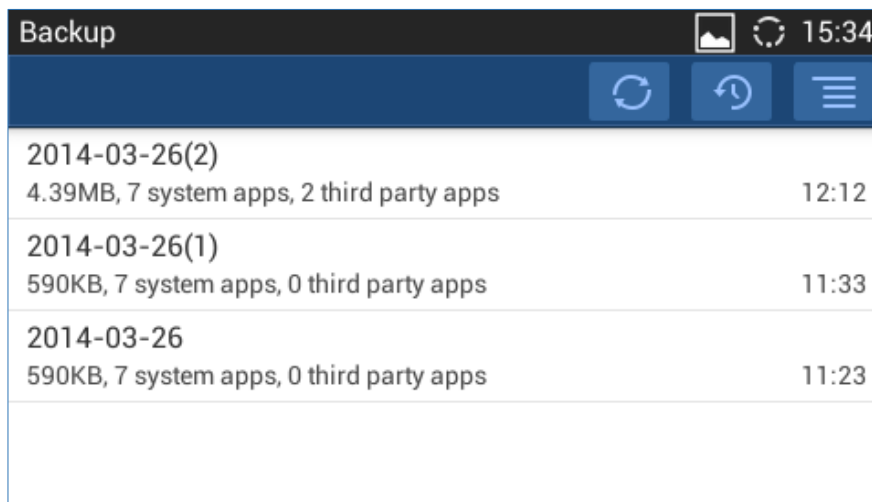



Figure 26: GXV3240 Backup

3. Tap on icon  to select the applications to be backed up.

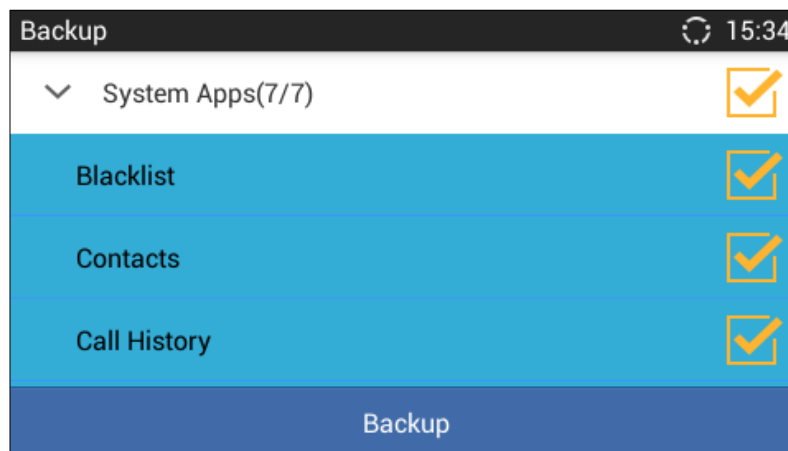





Figure 27: Select Backup Applications

4. Tap on "Backup" to start generating the backup file.
5. The backup file can be accessed from Backup application. If users touch and press on the backup file for about 2 seconds until the checkbox displays, users can then share the backup file by tapping on  or delete the file by tapping on .
6. Or users can go to FileManager→Internal Storage→Backup to retrieve the backup files.

Restore from Backup File

1. Open Backup application by tapping on icon  from phone's menu or desktop.
2. A list the previous backup files will be displayed with backup date and time. If the backup file you would like use is not displayed in the list, tap on  to scan backup files from phone's storage.
3. Tap on one of the backup file to select the applications to be restored from this backup.

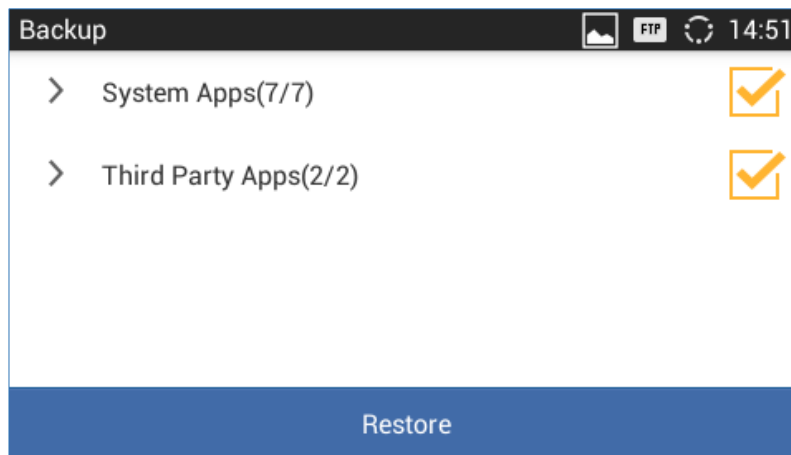

Figure 28: Select Backup Applications to Be Restored

4. Tap on "Restore" to start. The LCD will show restore status. Please wait until all the applications are completed or tap on "Cancel" to abort the restore process.

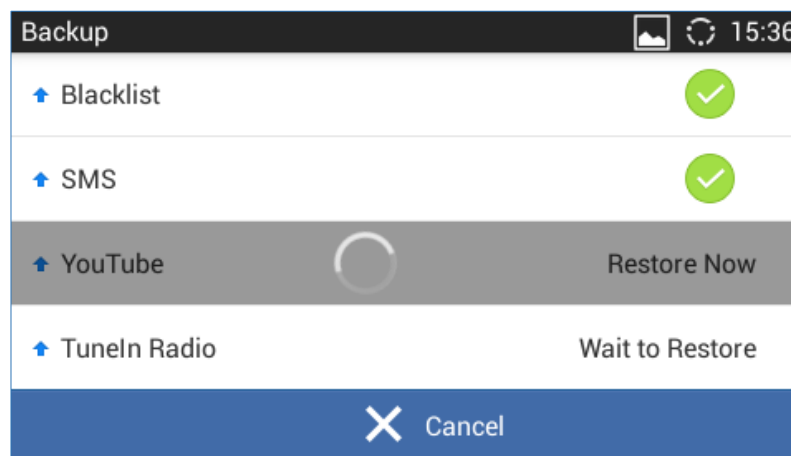



Figure 29: Restore Process

Automatic Backup

1. Open Backup application by tapping on icon  from phone's menu or desktop.
2. Tap on  and select "Auto Backup".
3. Configure the automatic backup settings.

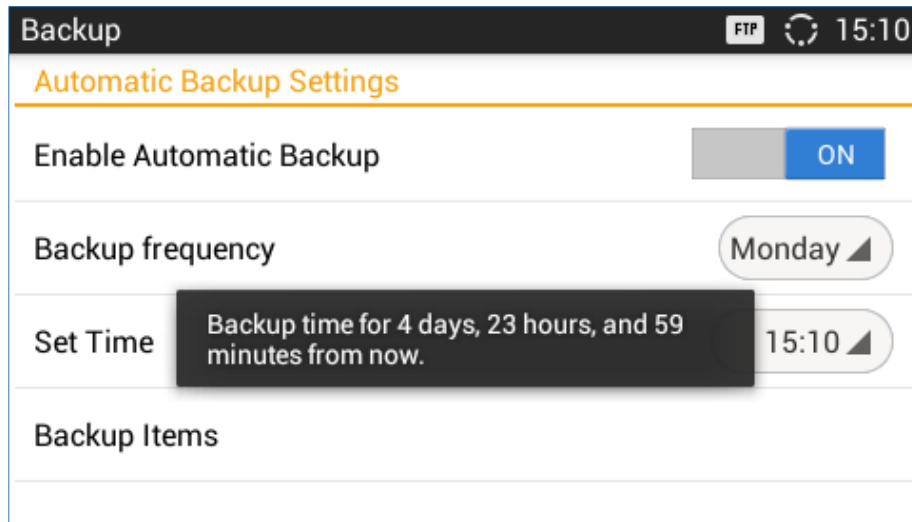

Figure 30: Automatic Backup Settings

- **Enable Automatic Backup.** Turn on the enable automatic backup on the phone.
- **Backup Frequency.** Select the day of the week for the phone to automatically start backup.
- **Set Time.** Select the hour and minute of the day for the phone to automatically start backup.
- **Backup Item.** Tap to select the applications you would like to backup automatically.

DATA WIPING

“Data Wiping” is available under **LCD Settings→Advanced Settings** and it allows users to restore all configuration settings on the phone and reset P-values to default.

 **Warning:**

Restoring the default settings using Data Wiping will delete all configuration information on the phone including configuration settings and application installed. Please backup or print all the settings before you restore to the factory default settings. Grandstream is not responsible for restoring lost parameters and cannot connect your device to your VoIP service provider.

1. On GXV3240 idle screen, press MENU button and tap on **System settings**. Or go to on screen MENU→**Settings**.
2. Tap on **Advanced Settings→Data Wiping**, the following figure will show.

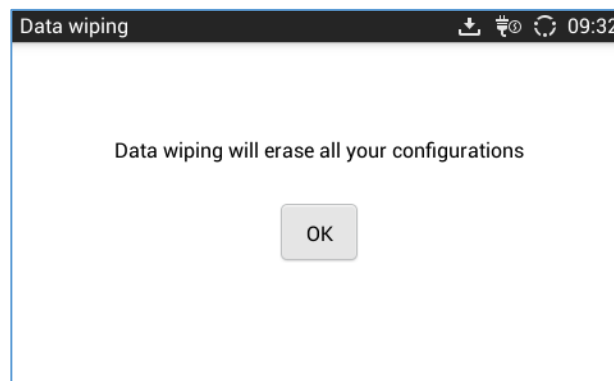

Figure 31: Data Wiping

3. Tap on Ok button, a confirmation message will show and invite users to reboot the phone to apply the default configuration settings as displayed on the following figure.

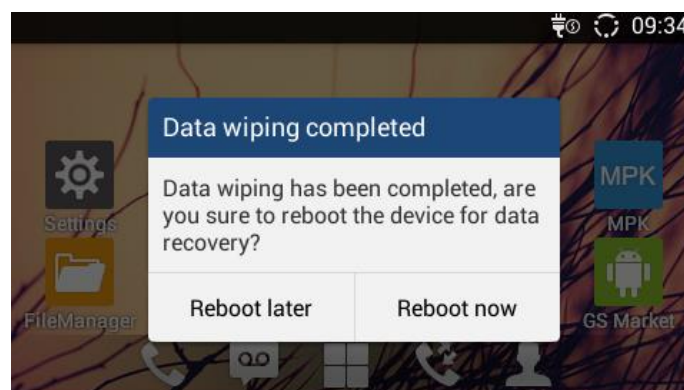

Figure 32: Reboot Confirmation Message

FACTORY RESET

Restore to Factory Default via LCD Menu

 **Warning:**

Restoring the Factory Default Settings will delete all configuration information on the phone. Please backup or print all the settings before you restore to the factory default settings. Grandstream is not responsible for restoring lost parameters and cannot connect your device to your VoIP service provider.

There are two methods to restore the GXV3240 to the factory default settings.

1. On GXV3240 idle screen, press MENU button  and tap on **System settings**. Or go to onscreen MENU→Settings.
2. Tap on **Advanced Settings→Factory Reset**, the following figure will show.

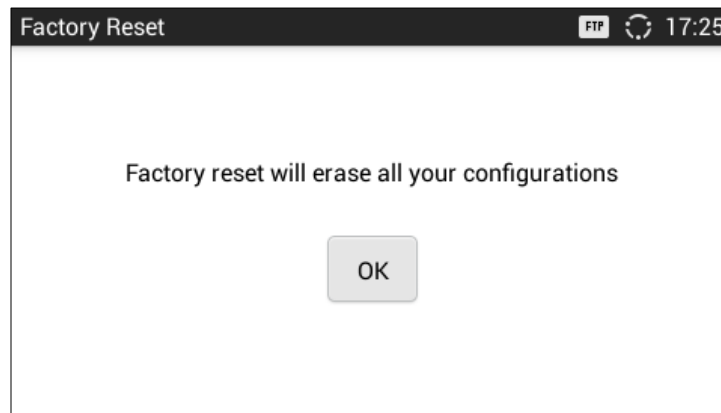

Figure 33: GXV3240 LCD - Factory Reset

3. Tap on **Factory Reset**, a confirmation message will show. Select "Clear the SD Card" if you would like to delete all the picture, videos and other files from the SD card storage on the GXV3240.

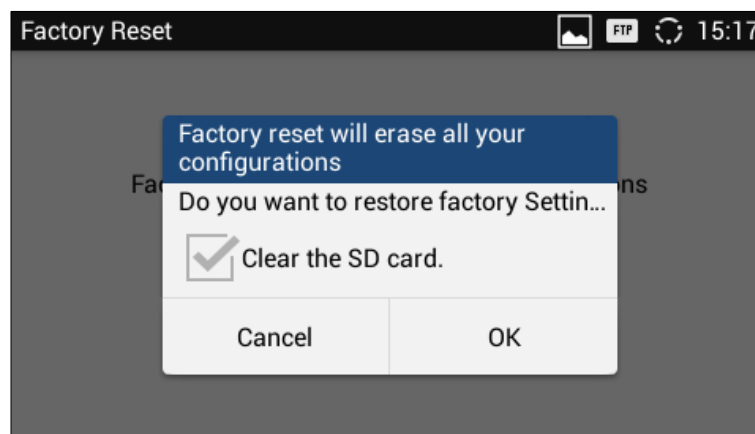

Figure 34: GXV3240 LCD - Confirm Factory Reset

4. Tap on **OK** to confirm.



Restore to Factory Default via the Web GUI

1. Login GXV3240 Web GUI and go to **Maintenance**→**Upgrade page**;
2. At the bottom of the page, click on the **Reset** button for Factory reset. Select "Clear the SD Card" if you would like to delete all the picture, videos and other files from the SD card storage on the GXV3240.



Figure 35: GXV3240 Web GUI - Factory Reset

3. A dialog box will pop up to confirm factory reset;
4. Click OK to restore the phone to factory settings.

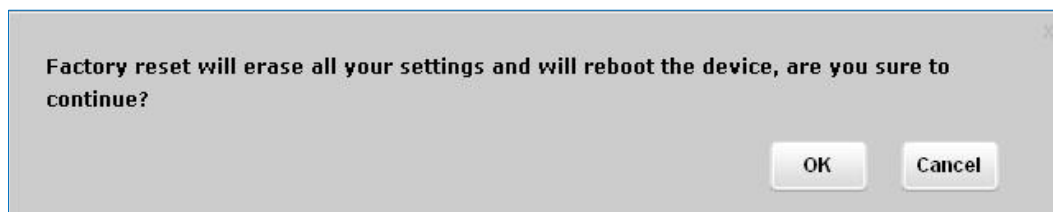

Figure 36: GXV3240 Web GUI - Confirm Factory Reset



Restore to Factory Default via Hard Keys

If users could not access web GUI for factory reset, or when the GXV3240 cannot boot up, pressing and holding 1 and 9 at the same time for about 5 seconds could reset the GXV3240 before it boots up. Follow the steps below to reset the GXV3240 via hard keys.

1. Power cycle the GXV3240 and the MWI LED will light up.
2. Wait until the MWI LED lights off and immediately pressing both 1 and 9 keys at the same time for about 8 seconds.
3. Release the keys once the MWI LED lights up again.
4. Wait for about 1 minute till the GXV3240 boots up again.
5. The GXV3240 will boot up with factory default settings.



SAFE MODE

The GXV3240 allows users to enter safe mode by pressing the Menu button  during bootup. Before entering the safe mode, please power cycle the phone and when the plain text "GRANDSTREAM" shows up, immediately press and hold the Menu button  until the phone completely boots up. Users will see the phone boot up in safe mode.

Under safe mode, only the system applications will be up and running. Normally safe mode is not needed unless the phone cannot function anymore caused by incompatible 3rd party applications. For example, if a 3rd party application is downloaded and installed on the phone that cause the phone keep crashing or freezing and users cannot operate on the phone's settings, users can enter safe mode to remove the 3rd party application and boot up in normal mode again.



EXPERIENCING THE GXV3240 APPLICATION PHONE

Please visit our website: <http://www.grandstream.com> to receive the most up- to-date updates on firmware releases, additional features, FAQs, documentation and news on new products.

We encourage you to browse our [product related documentation](#), [FAQs](#) and [User and Developer Forum](#) for answers to your general questions. If you have purchased our products through a Grandstream Certified Partner or Reseller, please contact them directly for immediate support.

Our technical support staff is trained and ready to answer all of your questions. Contact a technical support member or [submit a trouble ticket online](#) to receive in-depth support.

Thank you again for purchasing Grandstream Enterprise Application phone, it will be sure to bring convenience and color to both your business and personal life.

* Android is a trademark of Google Inc.

* Skype and Lync are Registered Trademarks of Microsoft Corporation.



HDMI, the HDMI Logo, and High-Definition Multimedia Interface are trademarks or registered trademarks of HDMI Licensing LLC in the United States and other countries.

