

ICF-1170I Series Quick Installation Guide

Edition 3.0, March 2016

Technical Support Contact Information **www.moxa.com/support**

Moxa Americas:

Toll-free: 1-888-669-2872

Tel: 1-714-528-6777

Fax: 1-714-528-6778

Moxa China (Shanghai office):

Toll-free: 800-820-5036

Tel: +86-21-5258-9955

Fax: +86-21-5258-5505

Moxa Europe:

Tel: +49-89-3 70 03 99-0

Fax: +49-89-3 70 03 99-99

Moxa Asia-Pacific:

Tel: +886-2-8919-1230

Fax: +886-2-8919-1231

Moxa India:

Tel: +91-80-4172-9088

Fax: +91-80-4132-1045

MOXA®

© 2016 Moxa Inc. All rights reserved.

P/N: 1802011700012



Overview

Introduction

The ICF-1170I series is a CAN-to-fiber optic converter that secures data transmission by using fiber optic transmission to provide complete isolation and protection against EMI.

The ICF-1170I series can separate and protect critical segments of the system from the rest of the CAN network and is protocol independent, allowing it to work with all of the different CAN protocols and frame lengths.

To connect two CAN devices with fiber optic cable, two ICF-1170I series converters are required.

Why Convert CAN to Fiber?

- **IMMUNITY FROM ELECTRICAL INTERFERENCE**
Fiber is not affected by electromagnetic interference or radio frequency interference; consequently it provides a clean communication path and is immune to crosstalk.
- **INSULATION**
Optical fiber is an insulator; the glass fiber eliminates the need for using electric current as the communication medium.
- **SECURITY**
Optical fiber provides better security compared to traditional electrical signals transmitted through a wire or radio waves transmitted through the air. Since the light rays travel down the center of the fiber, it is extremely difficult for them to escape. In addition, it is nearly impossible to tap into a fiber optic cable, and even if a tap is successful, it is possible to detect the tap by monitoring the optical power received at the termination point.
- **RELIABILITY AND MAINTENANCE**
Fiber is immune to adverse temperature and moisture conditions, does not corrode or lose its signal, and is not affected by short circuits, power surges, or static electricity.

Fiber Test Mode

The ICF-1170I supports a special feature called **Fiber Test Mode**, which is easily activated with a DIP switch on the ICF-1170I's outer panel.

Fiber Test Mode can be used to test the fiber cable between two ICF-1170I units and provides a simple way to determine if the fiber cable is transmitting data correctly.

When in **Fiber Test Mode**, the fiber transceiver (TX) will send out a data signal continuously and the "Fiber TX" LED will light up. On the other side of the connection, when the ICF-1170I fiber transceiver (RX) receives the data signal from the TX side, the "Fiber RX" LED will light up.

Alarm Contact Output

The ICF-1170I supports dual power inputs for redundancy. When one power input fails, the relay will be triggered. Be sure to install the dual power inputs for the ICF-1170I series, and choose the correct relay output when connecting the alarm.

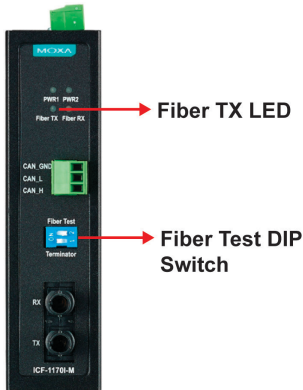

Features

- Transmission distance up to 2 km
- Convert CAN signals to fiber and fiber to CAN signals
- CAN transfer rate up to 1 Mbps
- Dual power inputs for redundancy
- DIP switch for 120 Ω terminal resistance
- DIP switch for fiber test mode
- Wide temperature range model available for -40 to 85°C environments

Package Checklist

Before installing the ICF-1170I series, verify that the package contains the following items:

- ICF-1170I series CAN-to-fiber Converter
- Quick Installation Guide (printed)
- Warranty Card

NOTE: *Please notify your sales representative if any of the above items are missing or damaged.*

Mounting Dimensions (Unit: mm)

ICF-1170I-M-ST

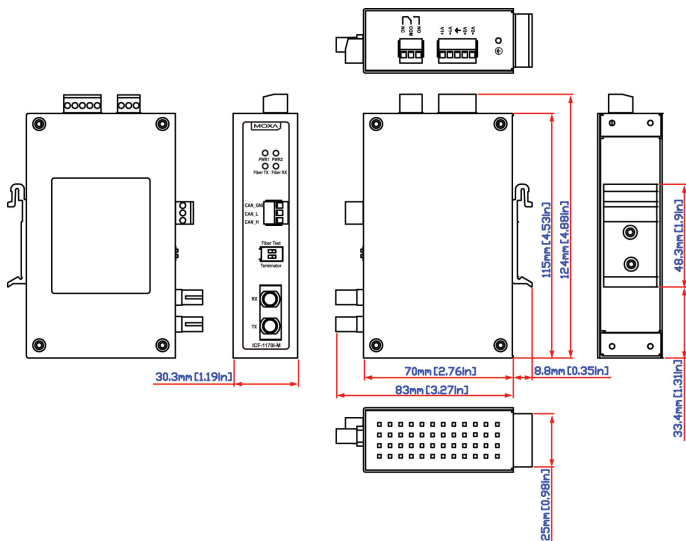

Top View

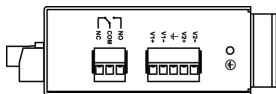

Front View

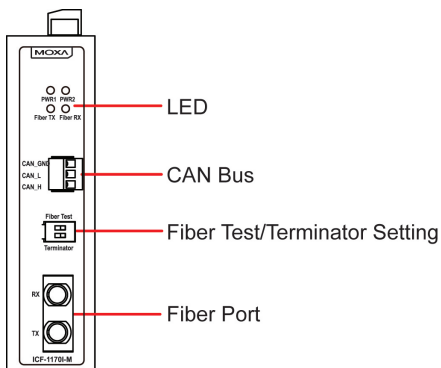



ATTENTION

Electrostatic Discharge Warning!

To protect the product from damage due to electrostatic discharge, we recommend wearing a grounding device when handling your ICF-1170 series.

Mounting

The aluminum DIN-rail attachment plate should be fixed to the back panel of the ICF-1170I series when you take it out of the box. If you need to reattach the DIN-rail attachment plate to the ICF-1170I, make sure the stiff metal spring is situated towards the top, as shown in the figures below.

Step 1:

Insert the top of the DIN-rail into the slot just below the stiff metal spring.

Step 2:

The DIN-rail attachment unit will snap into place as shown below

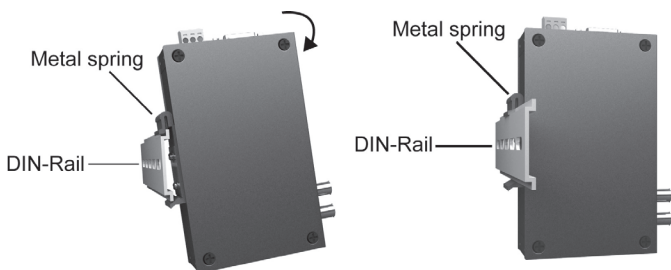

To remove the ICF-1170I series from the DIN-rail, simply reverse Steps 1 and 2 above.

Fiber Cable

ST-Port Pinouts

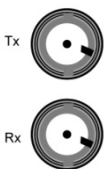

ST-Port to ST-Port Cable Wiring

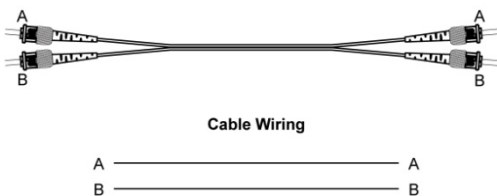

ATTENTION

This is a Class 1 laser/LED product. Do not stare into the laser beam.

Switch Settings

There are two DIP switches on the front panel of the ICF-1170I series.

120 Ω Terminator	Switch 1
Enable	ON
Disable	OFF (default)

Fiber Test Mode	Switch 2
Enable	ON
Disable	OFF (default)

LED Indicators

There are 4 LEDs on the front panel of the ICF-1170I.

LED	Color	Function
PWR 1	Green	Steady ON: Power source 1 is ON.
PWR 2	Green	Steady ON: Power source 2 is ON.
Fiber Tx	Green	When sending CAN data to the fiber port.
Fiber Rx	Orange	When receiving CAN data from the fiber port.

Typical CAN Application

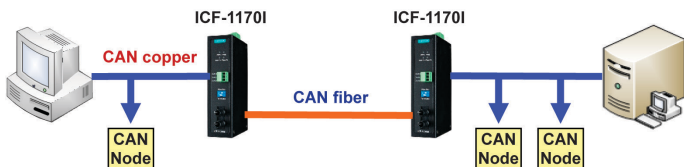

Specifications

CAN Communication

CAN Bus Interface:	ISO 11898-2, Terminals (CAN_H, CAN_L, CAN_GND)
Protocols Supported:	CAN 2.0A and 2.0B (ISO 11898-2)
CAN Connector:	3-pin removable screw terminal x1
Termination Resistor:	Dip switch selector for 120 Ω terminal resistor
Baudrate:	Up to 1 Mbps
System Delay:	150 ns
Isolation Protection:	2 KV
Transmission Length:	Max. 2 KM (depends on the data rate and the protocol used)

Baud Rate	Fiber Length
1000 kbps	10 m
500 kbps	100 m
250 kbps	250 m
125 kbps	400 m
50 kbps	1000 m
10 kbps	2000 m

Note: CAN Bus cable length is 30 m.

LED Indicators: PWR1, PWR2, Fiber TX, Fiber RX

Note: The transmission distance is limited by the signal rate, as mentioned in the ISO 11898-2 standard.

Fiber Communication

Connector Type:	ST (multimode) fiber ports x 2
Support Cable :	50/125, 62.5/125, or 100/140 μm (multimode)
Wavelength:	850 nm
TX Output:	> -5 dBm
RX Sensitivity:	-20 dBm

Environmental Limits

Operating Temperature:	0 to 60°C (32 to 140°F), 5 to 95 % RH -40 to 85°C (-40 to 185°F) for -T model
Storage Temperature:	-40 to 85°C (-40 to 185°F), 5 to 95 % RH

Power

Input Power Voltage:	12 to 48 VDC dual power input for redundancy
Alarm contact:	1 normal open/close output with current-carrying capacity of 1 A@24VDC

Mechanical Specifications

Dimensions:	30.3 x 70 x 115 mm
Material:	Aluminum (1 mm)
Gross Weight:	135 g

Regulatory Approvals

CE:	Class A
FCC:	Part 15 sub Class A
UL:	UL-508
LVD:	EN 60950-1
EMI:	EN55022 1998, Class A
EMS:	EN61000-4-2 (ESD), Criteria B, Level 4 EN61000-4-3 (RS), Criteria A, Level 2 EN61000-4-4 (EFT), Criteria B, Level 4 EN61000-4-5 (Surge), Criteria B, Level 2 EN61000-4-6 (CS), Criteria B, Level 2 En61000-4-8 (PFMF), Criteria A, Level 3
Freefall:	IEC 60068-2-32
MTBF:	792085 hrs.

Ordering Information

Available models:

- **ICF-1170I-M-ST:** CAN-to-fiber converter, multimode, ST connector.
- **ICF-1170I-M-ST-T:** CAN-to-fiber converter, multimode, ST connector, -40 to 85°C.