

MPC-2190 Panel Computer Hardware Manual

Second Edition, March 2015

www.moxa.com/product

MOXA[®]

© 2015 Moxa Inc. All rights reserved.

MPC-2190 Panel Computer Hardware Manual

The software described in this manual is furnished under a license agreement and may be used only in accordance with the terms of that agreement.

Copyright Notice

© 2015 Moxa Inc. All rights reserved.

Trademarks

The MOXA logo is a registered trademark of Moxa Inc.
All other trademarks or registered marks in this manual belong to their respective manufacturers.

Disclaimer

Information in this document is subject to change without notice and does not represent a commitment on the part of Moxa.

Moxa provides this document as is, without warranty of any kind, either expressed or implied, including, but not limited to, its particular purpose. Moxa reserves the right to make improvements and/or changes to this manual, or to the products and/or the programs described in this manual, at any time.

Information provided in this manual is intended to be accurate and reliable. However, Moxa assumes no responsibility for its use, or for any infringements on the rights of third parties that may result from its use.

This product might include unintentional technical or typographical errors. Changes are periodically made to the information herein to correct such errors, and these changes are incorporated into new editions of the publication.

Technical Support Contact Information

www.moxa.com/support

Moxa Americas

Toll-free: 1-888-669-2872

Tel: +1-714-528-6777

Fax: +1-714-528-6778

Moxa Europe

Tel: +49-89-3 70 03 99-0

Fax: +49-89-3 70 03 99-99

Moxa China (Shanghai office)

Toll-free: 800-820-5036

Tel: +86-21-5258-9955

Fax: +86-21-5258-5505

Moxa Asia-Pacific

Tel: +886-2-8919-1230

Fax: +886-2-8919-1231

Table of Contents

1. Introduction	1-1
Overview	1-2
Ordering Information	1-2
Package Checklist	1-2
Product Features	1-3
MPC-2190 Hardware Specifications	1-3
MPC-2190 Available Option Table	1-5
Hardware Block Diagram	1-6
2. Hardware Introduction	2-1
Appearance	2-2
Front View	2-2
Bottom View	2-2
Dimensions	2-3
SavvyTouch Display Control Buttons	2-3
Real Time Clock	2-4
3. Hardware Connection Description	3-1
Placement Notes	3-2
Desktop Mounting	3-3
Wall Mounting	3-3
VESA Mounting	3-5
Wiring Requirements	3-6
Temperature Requirements	3-6
Important Safety Precaution	3-6
Grounding the MPC-2190 Series	3-6
Powering on/off the MPC-2190 Series	3-7
SavvyTouch Display Control Buttons	3-7
Extending the Displays	3-8
Connecting Data Transmission Cables	3-9
Connecting to a Network	3-9
Connecting to a Serial Device	3-10
Connecting to NMEA 0183 Devices	3-12
Connecting to a Speaker or a Headphone	3-12
Connecting a PS/2 Keyboard and Mouse	3-12
Connecting to USB Devices	3-12
Installing a SATA HDD or SSD	3-13
4. Display Resolution and Touch Calibration	4-1
Installing the VGA Driver	4-2
Adjusting Display Resolution	4-6
Installing the Touchscreen Driver	4-7
Screen Calibration	4-12
5. BIOS Setup	5-1
Entering the BIOS Setup Utility	5-2
Main Information	5-3
Advanced Settings	5-3
Boot Configuration	5-4
HDC Configuration	5-4
Video Configuration	5-5
Chipset Configuration	5-7
Hardware Monitor	5-8
Security Settings	5-8
Set Supervisor Password	5-9
Power Settings	5-9
Boot Settings	5-10
Boot Type	5-10
PXE Boot to LAN	5-10
Add Boot Options	5-10
USB Boot	5-10
EFI Device First	5-10
Boot Delay Time	5-11
Legacy	5-11
Exit Settings	5-12
Exit Saving Changes	5-12
Save Change Without Exit	5-12
Exit Discarding Changes	5-12
Load Optimal Defaults	5-12
Load Custom Defaults	5-12
Save Custom Defaults	5-13

Discard Changes	5-13
Upgrading the BIOS	5-13
6. Display Control Interface	6-1
Connecting to the Console Interface.....	6-2
Display Control Interface Command Format	6-4
Command Format Description	6-4
Downloading RGB Files.....	6-7
A. Regulatory Approval Statement	A-1
B. Display Control Interface Commands	B-1
Display Control Interface Commands.....	B-2
BRI (Brightness Minimum Value)	B-2
BRL (Set LED Brightness of Touch Keypad).....	B-2
BRM (Brightness Maximum Value)	B-2
BRT (User Brightness Control)	B-2
BRU (Glass Display Control-Brightness Button)	B-2
BZZ (Buzzer Control)	B-3
DLN (Download ECDIS RGB Package)	B-3
DL? (ECDIS RGB Package Query)	B-3
ETC (Elapsed Time Counter Query).....	B-3
GMB (Glass Display Control - Minimum Brightness)	B-4
POT (Potentiometer Control).....	B-4
SWI (Scalar Firmware Version Query)	B-4
SWK (Touch Keypad Firmware Version Query)	B-4
ADF (AC Input Power Detect Function)	B-4
AD? (Query AC Input Power Detect Function Status).....	B-5
BLI (Brightness Control).....	B-5
DUF (Disable UART Command Function).....	B-5
EMS (ECDIS Mode Select)	B-5

Introduction

In this chapter, we give a general introduction to the features and specifications of MPC-2190 panel computers.

The following topics are covered in this chapter:

- **Overview**
- **Ordering Information**
- **Package Checklist**
- **Product Features**
- **MPC-2190 Hardware Specifications**
 - MPC-2190 Available Option Table
- **Hardware Block Diagram**

Overview

MPC-2190 panel computers feature advanced Intel processors—3rd generation Ivy Bridge Core or Celeron—matched to 4 GB of system memory, to deliver a reliable, high-performance platform of wide versatility for use in industrial marine environments. With its RS-232/422/485 serial, NMEA 0183, and Gigabit Ethernet LAN ports, the MPC-2190 panel computer supports a wide variety of serial- and marine-specific interfaces alongside high speed IT communications, all with native network redundancy.

The MPC-2190 series comes with a range of standard display enhancements useful in industrial environments (including 0 to 100% full range dimming, 178°/178° wide viewing angles, optional optical bonding, and/or multi-touch screen), as well as Moxa's innovative SavvyTouch display controls.

MPC-2190 panel computers are compliant with several industrial marine standards, such as IEC 60945 4th, IEC 61174, IEC 61162, DNV2.4, and IACS E10, verifying their resilient durability in marine operations. An optional IP65-rated unibody shell provides strong additional protection against the harsh conditions found in marine environments. The MPC-2190 delivers a rugged, type approved, high-performance and user-friendly panel computer perfect for ECDIS navigation systems and other marine IBS applications.

Ordering Information

The MPC-2190 series includes the following models:

- **MPC-2190X:** 19-inch fanless panel computer with Intel Celeron 1047UE 1.4 GHz processor, NMEA 0183, RS-232/422/485 serial ports, Gigabit Ethernet LAN ports, USB 2.0 ports, dual AC/DC power inputs, and tape bonding
- **MPC-2190Z:** 19-inch fanless panel computer with Intel Celeron 1047UE 1.4 GHz processor, NMEA 0183, RS-232/422/485 serial ports, Gigabit Ethernet LAN ports, USB 2.0 ports, dual AC/DC power inputs, and tape bonding, projected capacitive touchscreen
- **MPC-2197X:** 19-inch fanless panel computer with Intel Core i7 2610UE 1.5 GHz processor, NMEA 0183, RS-232/422/485 serial ports, Gigabit Ethernet LAN ports, USB 2.0 ports, dual AC/DC power inputs, and tape bonding

The following **optional accessory packages** are available on request:

- Desktop mounting kit
- Wall mounting clamps
- VESA mounting kit

Package Checklist

The MPC-2190 panel computer is shipped with the following items:

- 1 MPC-2190 series panel computer
- 1 terminal block for DC power input
- 4 5-pin Euroblock terminals for NMEA 0183 v2 interfaces
- 2 HDD installation brackets
- Documentation and driver DVD
- Quick installation guide (printed)
- Warranty card

NOTE Notify your sales representative if any of the above items are missing or damaged.

Product Features

The MPC-2190 series panel computer has the following features:

- 19-inch panel
- Color calibrated for ECDIS compliance
- Fanless design
- SavvyTouch display controls
- 3rd Generation Intel® Core™ or Celeron® processor (default: Celeron® 1047UE, 1.40 GHz with Intel® HD Graphics)
- Built-in NMEA 0183 and software selectable RS-232/422/485 interfaces (DI/DO and LPT available on request)
- Dual AC/DC power supply units
- Optically bonded and touch panel models available on request

MPC-2190 Hardware Specifications

Computer

CPU: Intel Celeron® Processor 1047UE (2M Cache, 1.4 GHz)

OS: Windows 7 Professional, Windows Embedded Standard 7, Windows XP Embedded, Windows XP SP3 (models with OS pre-installed available on request)

System Chipset: Intel BD82HM65 platform controller hub

System Memory: 4 GB pre-installed: 1 slots of 4 GB DDR3-1066 204 pin SO-DIMM SDRAM

USB: USB 2.0 hosts x 4, type A connectors, supporting system boot up

Storage: 2 SATA-III connectors

BIOS: 64 Mbit Flash BIOS SPI type, ACPI function supported

Graphics Controller: Intel HM65 Express chipset built-in

Video Output: DVI-D x 1, VGA x 1 (female)

Digital Input/Output: 4 DIs, 4 DOs, or 8 DIs, 8 DOs (optional)

LPT Port: 1 (available on request)

Buzzer: 75 to 85 db (IEC 60945 complied)

Other Peripherals

Audio: Line-in and line-out interface, with 3.5 mm mini jack

KB/MS: 2 PS/2 interface supporting standard PS/2 keyboard and mouse

Display

Panel Size: 19 inch wide viewable image size

Panel Type: MVA

Aspect Ratio: 5:4

Pixels: 1280 x 1024 (SXGA)

Response Time: 20 ms

Contrast Ratio: 2000:1

Light Intensity: 300 cd/m²

Viewing Angles: 178°/178°

Active Display Area: 376.32 (H) x 301.06 (V) mm

Max Colors: 16.7M (8 bits/color)

Display Interface: Dual channel LVDS

Resolution:

- VGA: 640 x 480
- SVGA: 800 x 600
- XGA: 1024 x 768
- SXGA: 1280 x 1024

Ethernet Interface

LAN: 2 auto-sensing 10/100/1000 Mbps ports (RJ45)

Magnetic Isolation Protection: 1.5 kV built-in

Serial Interface

Serial Standards: 2 RS-232/422/485 ports, software-selectable (DB9 male)

Serial Communication Parameters

Data Bits: 5, 6, 7, 8

Stop Bits: 1, 1.5, 2

Parity: None, Even, Odd, Space, Mark

Flow Control: RTS/CTS, XON/XOFF, ADDC® (automatic data direction control) for RS-485

Baudrate: 50 bps to 115.2 Kbps (supports non-standard baudrates; see user's manual for details)

Serial Signals

RS-232: TxD, RxD, DTR, DSR, RTS, CTS, DCD, GND

RS-422: TxD+, TxD-, RxD+, RxD-, GND

RS-485-4w: TxD+, TxD-, RxD+, RxD-, GND

RS-485-2w: Data+, Data-, GND

NMEA Interface

Serial Standards: 4 NMEA 0183 ports

Base Serial Standard: RS-422

Optical Isolation Protection: ±6kV contact discharge, ±8kV air discharge

Voltage Differential: -15 V to + 15 V

Baudrate: 4800 bps

Data Bits: 8

Stop Bits: 1, 1.5, 2

Parity: None

Handshake: None

LEDs

System: Storage, Power

LAN: 100M/Link x 2, 1000M/Link x 2 (on connector)

Front Panel

LEDs: MENU, Brightness, INFO, ECDIS, Day/Dusk/Night, Storage

Smart OSD: Yes

Physical Characteristics

Housing: Aluminum sheet metal

Weight: 7.8 kg

Dimensions: 429 x 387 x 74.5 mm (16.89 x 15.24 x 2.93 in)

Mounting: Flush mounting

System Cooling: Fanless thermal design

Environmental Limits

Operating Temperature: -15 to 55°C (5 to 131°F)

Storage Temperature: -20 to 60°C (-4 to 140°F)

Ambient Relative Humidity: 5 to 95% (non-condensing)

IP Rating:

- Front: IP 54
- Rear: IP 22

Anti-Vibration:

- 0.7 g @ DNV 2.4 (Class A), sine wave, 2-100 Hz, 1 Oct./min., 1.5 hr per axis
- 1 g @ DNV 2.4, random wave, 3-100 Hz, 2.5 hr per axis
- 1 g @ DNV 2.4 (Class C), sine wave, 2-50 Hz, 1 Oct./min., 1.5 hr per axis

Power Requirements

Input Voltage: 115 to 230 VAC, 50/60 Hz, 24 VDC

Power Consumption: 40 W to 125 W (max.)

Standards and Certifications

Safety: UL 60950-1, CCC

EMC: EN 55022 Class B, EN 55024-4-2, EN 55024-4-3, EN 55024-4-4, FCC Part 15 Subpart B Class A

Marine Standard: IEC-60945 4th, IEC-61162, IEC-61174

Marine Type Approval: DNV 2.4 and IACS E10, ABS, MR-A003

Green Product: RoHS, cRoHS, WEEE

Reliability

MTBF (mean time between failures): 202,309 hrs

Automatic Reboot Trigger: Built-in WDT (watchdog timer) supporting 1-255 levels for time interval system reset, software programmable

Warranty

Warranty Period: 1 year

Details: See www.moxa.com/warranty

MPC-2190 Available Option Table

The MPC-2190 can be customized with different hardware specifications. Refer to the following table for details.

CPU	Default	Intel Celeron® processor 1047UE (2M Cache, 1.40GHz), TDP 17 watts
	Options	Intel Core™ i3 processor 3217UE (3M Cache, 1.60GHz), TDP 17 watts Intel Core™ i7 processor 3517UE (4M Cache, 2.80GHz), TDP 17 watts
RAM	Default	4 GB
	Option	8 GB (max.)
OS	Default	N/A
	Options	Windows 7 Professional Windows XP Embedded Windows Embedded Standard 7 Windows XP SP3 Linux Debian 7
Factory Options	Projected capacitive touch screen (multi-touch, USB interface) Optical bonding Customized options for SSD drives	

Hardware Block Diagram

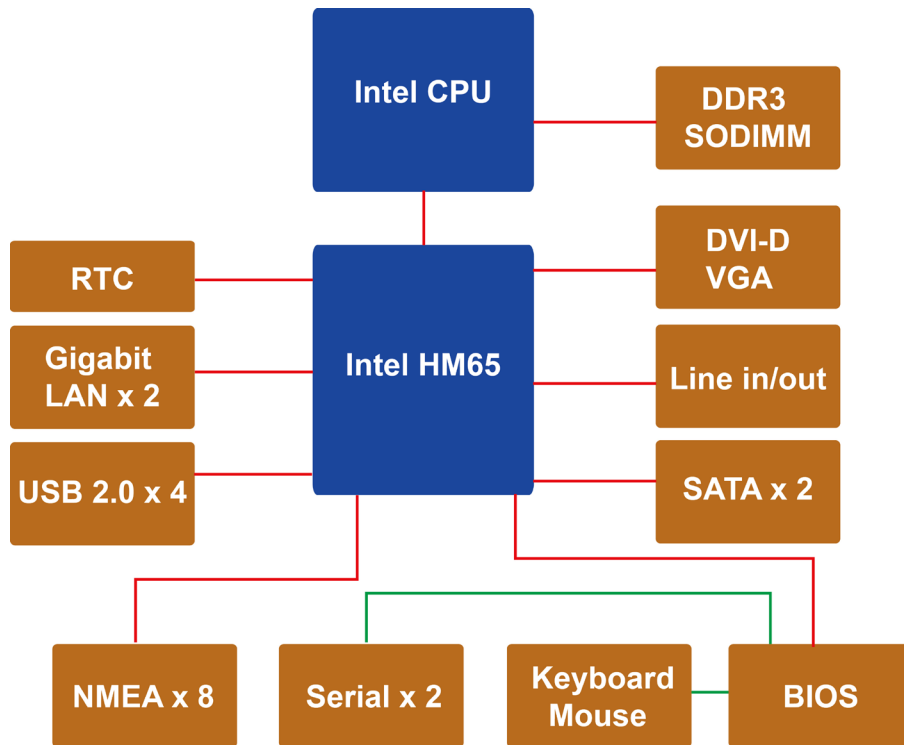

Hardware Introduction

The MPC-2190 Series computer is compact, well-designed, and ruggedized for marine applications. The intelligent SavvyTouch display control buttons allow you to indicate control buttons easily in low light environment and identify system hardware failure easily. Multiple serial ports allow you to connect different devices for data operation, and the reliable and stable hardware platform lets you devote your attention to developing your applications.

The following topics are covered in this chapter:

- ❑ **Appearance**
 - Front View
 - Bottom View
- ❑ **Dimensions**
- ❑ **SavvyTouch Display Control Buttons**
- ❑ **Real Time Clock**

Appearance

Front View

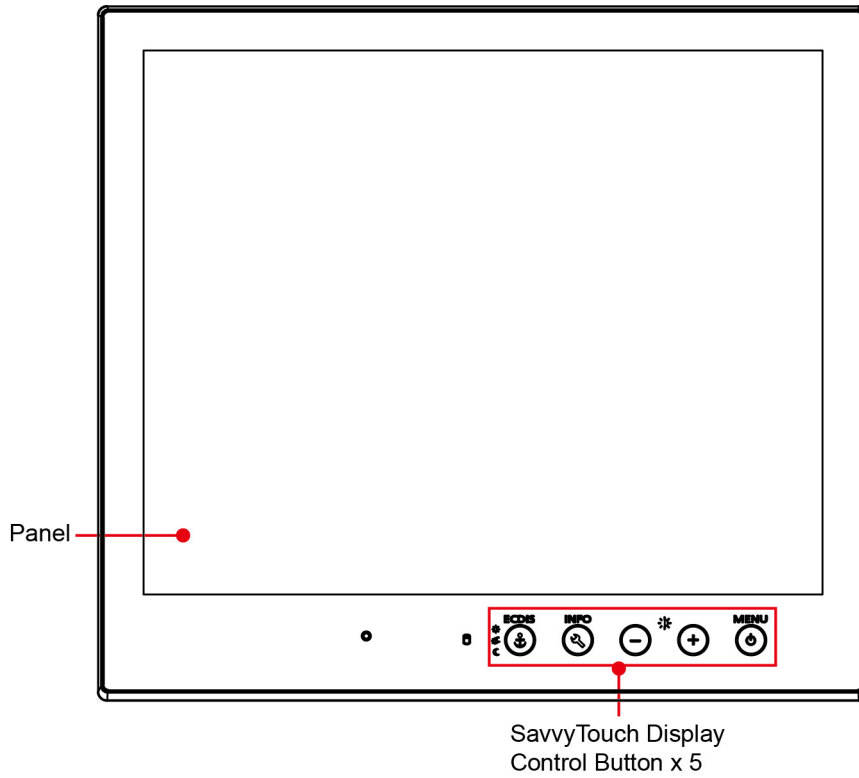

Bottom View

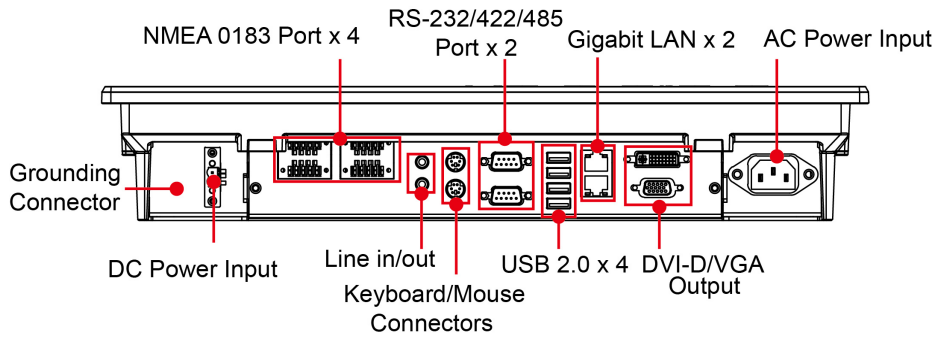



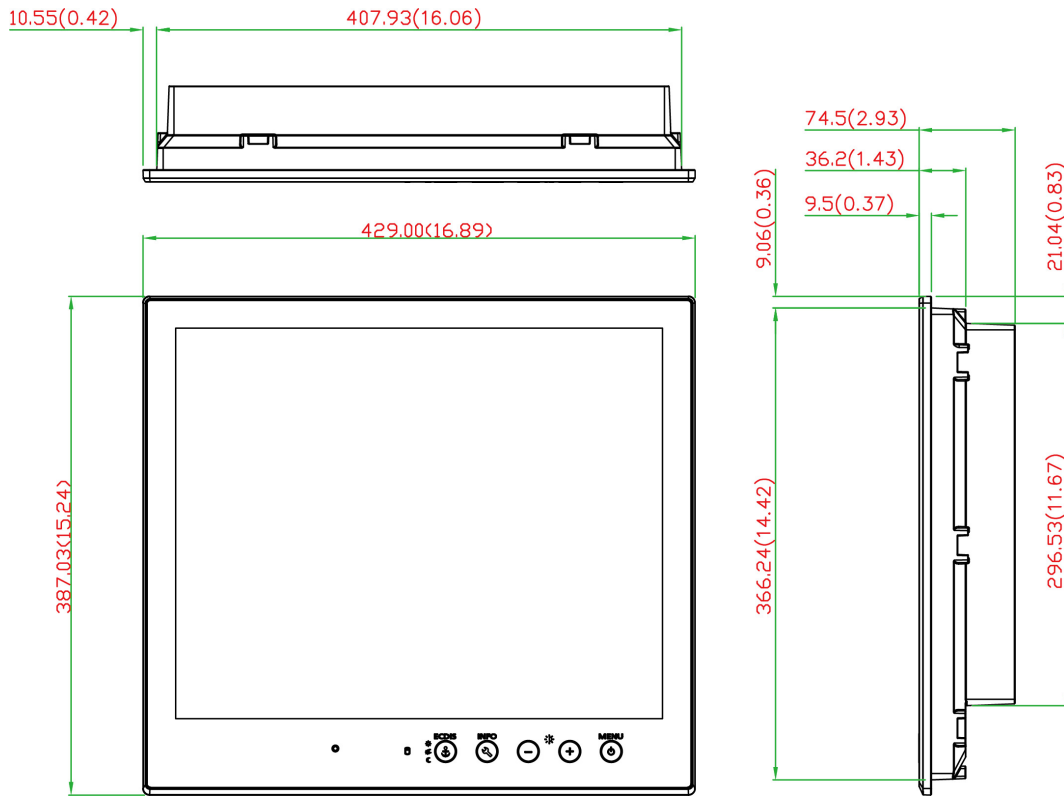

Dimensions



SavvyTouch Display Control Buttons

The MPC-2190 comes with SavvyTouch display control buttons located at the lower right corner of the front surface. These intelligent buttons will light up automatically when your fingers draw near. Refer to the following table for the function of each button.

Name	Displayed Color	Control Function / Color Legend
 Power	Green	Computer is powered on and functioning normally
	Red	Power standby and system shut down
	Off	Power is off.
 Brightness	White	+: To increase brightness of panel
		-: To decrease brightness of panel
 Info	Off	System functioning normally
	Red	System hardware error
 Storage	Red (on)	Storage drive is functioning properly
	Red (blinking)	Drive is accessing or writing data
	Off	Drive is offline.
 Display mode	White	Displays the brightness mode
	Off	Panel brightness out of ECDIS standard range

Real Time Clock

The computer's real-time clock is powered by a lithium battery. We strongly recommend that you **NOT** replace the lithium battery on your own. If the battery needs to be changed, please contact the Moxa RMA service team.



ATTENTION

There is a risk of explosion if the wrong type of battery is used. To avoid this potential danger, always be sure to use the correct type of battery. Contact the Moxa RMA service team if you need to replace your battery.

Hardware Connection Description

In this chapter, we show how to connect the panel computer to the network and to various devices.

The following topics are covered in this chapter:

❑ **Placement Notes**

- Desktop Mounting
- Wall Mounting
- VESA Mounting

❑ **Wiring Requirements**

❑ **Temperature Requirements**

- Important Safety Precaution

❑ **Grounding the MPC-2190 Series**

❑ **Powering on/off the MPC-2190 Series**

- SavvyTouch Display Control Buttons

❑ **Extending the Displays**

❑ **Connecting Data Transmission Cables**

- Connecting to a Network
- Connecting to a Serial Device
- Connecting to NMEA 0183 Devices

❑ **Connecting to a Speaker or a Headphone**

❑ **Connecting a PS/2 Keyboard and Mouse**

❑ **Connecting to USB Devices**

❑ **Installing a SATA HDD or SSD**

Placement Notes

Before installing and mounting the MPC-2190 panel computer, please read the following notes:

1. The MPC-2190 series is designed for various installation or mounting methods, for example: desktop mounting, wall mounting, and VESA mounting. Please refer to the relevant mechanical drawings in the next sections before attempting to mount the panel.
2. It is advised that good ventilation is necessary to prolong the computer's lifespan. The chassis' heat-sink area **MUST** be kept clear from other heat generating items, as this may damage the system motherboard. The minimal distance is 150 mm.
3. Allow sufficient physical space for proper ventilation, cable connectors, wiring passage, and practical maintenance purposes.
4. **DO NOT** install the unit in a horizontal position (laying down), as the heat inside of the unit is not dissipated effectively and will damage the LCD panel. It is recommended to install the unit in a vertical position (± 30 degrees) for better heat dissipation.
5. Exposure to extreme direct sunlight may cause a considerable increase in the temperature of the unit, and under certain circumstances might lead to overheating. Please take this point into consideration when the bridge equipment is being planned (sun shades, distance from the windows, ventilation, etc.)
6. Exposure to strong vibration or acoustic noise might affect the functionality and expected lifetime of the computer. Take consideration of these factors during system assembly and installation, to ensure the mounting position avoids exposure to strong vibrations.
7. For maximum safety, at least two persons should work together to lift, place, and fasten the computer to its mounting point. Before you lift or move the computer, first verify the computer is disconnected from any power source, and turned off. In addition, make sure you have prepared the correct screws for a wall mounting.

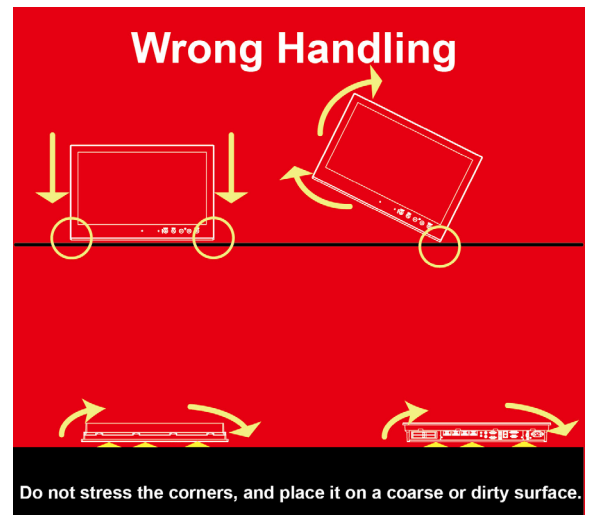
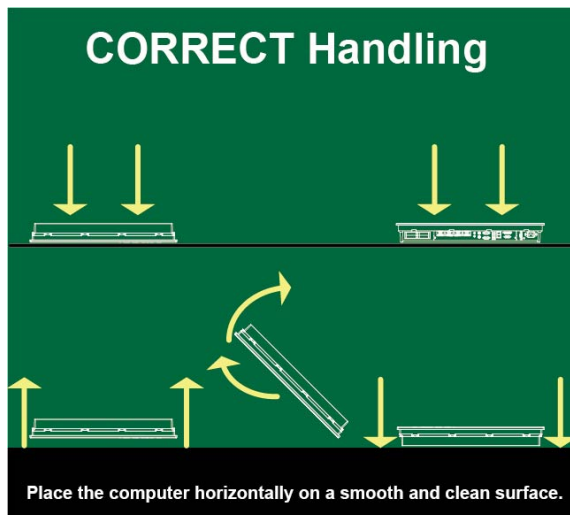

Desktop Mounting

The MPC-2190 comes with optional brackets that allow you to temporarily install the panel computer on a horizontal surface, such as a desktop. Three round screws are required for each bracket. See the figure below for detailed screw specifications and their torque value.

Desktop mounting of this sort is intended as a temporary workaround when configuring or testing the computer before permanent installation. The desktop mounting brackets should not be used for permanent installations.

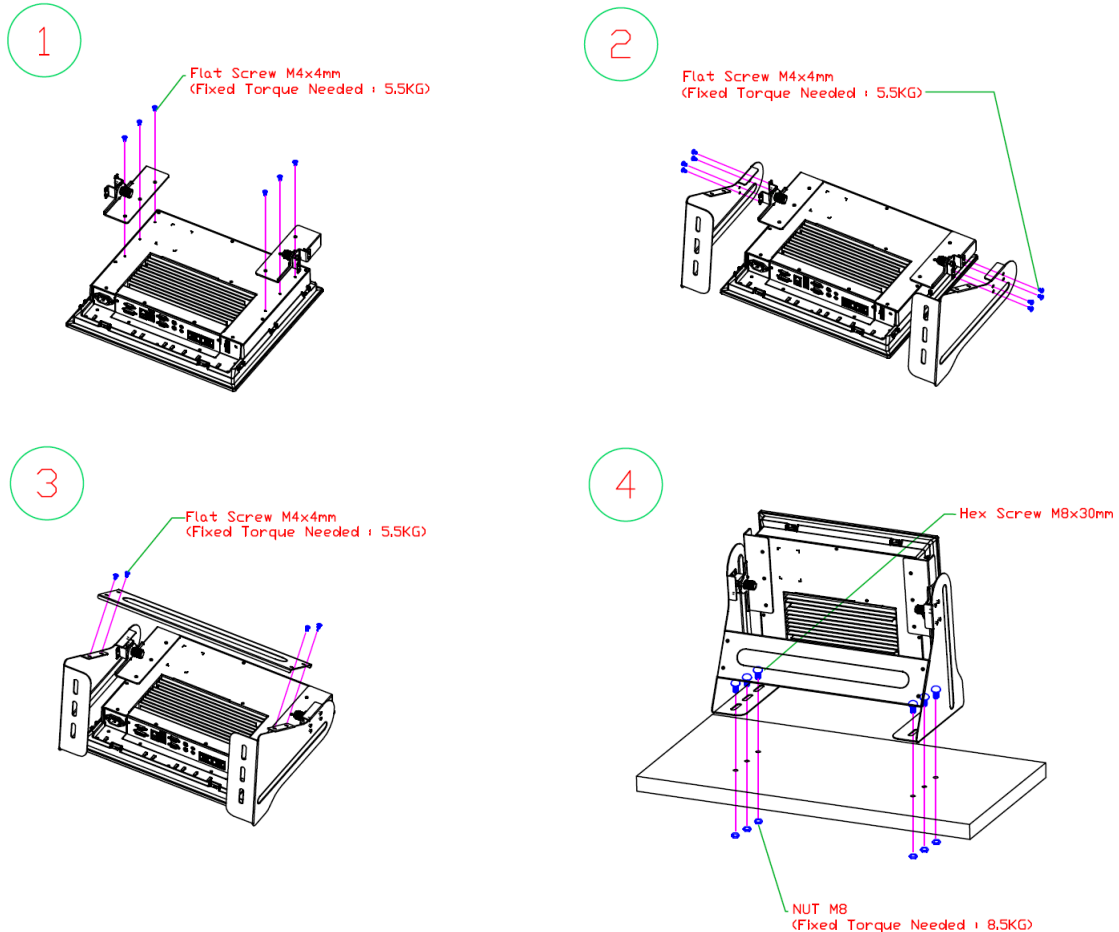

Place your MPC-2190 Series panel computer on a clean, flat, well-ventilated desktop. For better ventilation, leave some space between the MPC-2190 Series and other equipment. Do not place equipment or objects on top of the MPC-2190 Series panel computer, as this might damage the computer's internal components.

Wall Mounting

The MPC-2190 Series comes with 14 optional clamp mounts that allow for installation onto a wall (where space has been cut out to accommodate the rest of the hardware) or into computing stations where a flush mount is desired. **The maximum thickness of the surface to which the computer will be clamped is 11 mm.** For a secure mounting, all 14 clamps must be used. The clamp arms are fastened into slots on all four sides of the MPC-2190. Use the short M4 SUS (stainless) screws to fasten the clamp arms to the MPC-2190 mounting slots, as shown in the magnified inset in the diagram at the top of the next page. Next, use the clamps to fasten the computer to its mounting point; please note the torque value that is shown in the figure inset below.

Recommended Wall Cutout Dimension

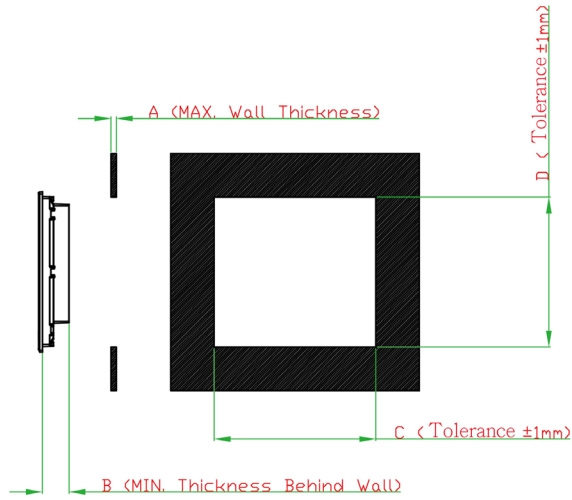

A	B	C	D	Mounting Kits (pcs)
12.0mm	65.0mm	411.0mm	368.0mm	10

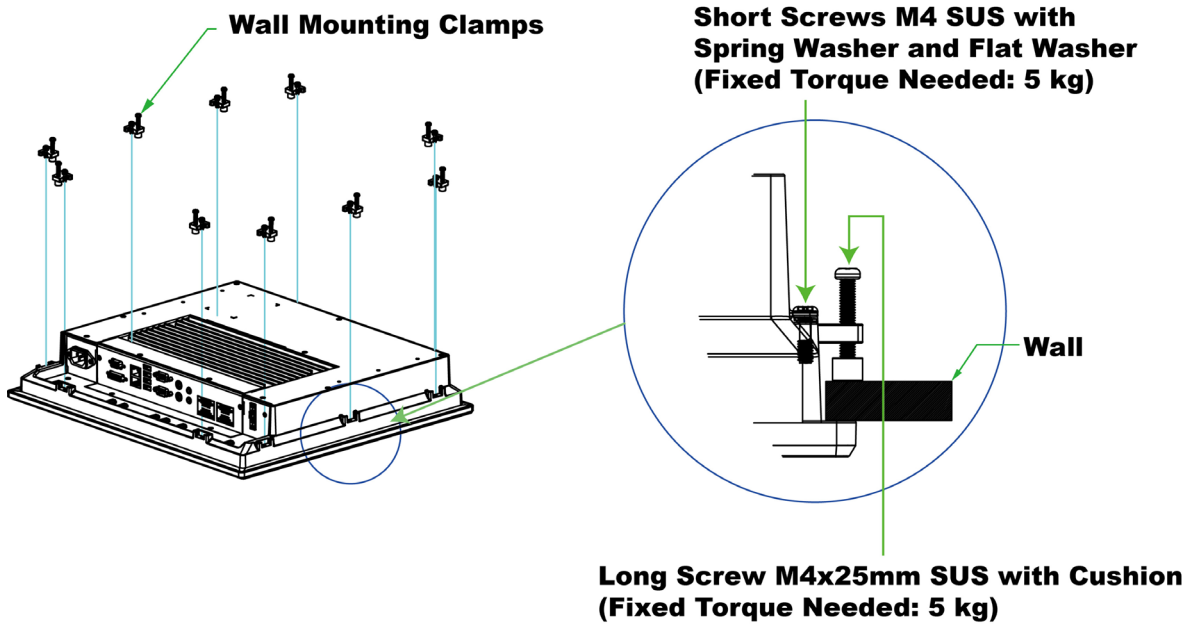

VESA Mounting

The MPC-2190 also comes with an optional VESA mounting kit. Six flat screws and four round screws are required to fasten the VESA mounting bracket. See the figure below for detailed screw specifications and torque values.

Round Screws M4x4mm SUS
(Fixed Torque Needed: 5 kg)

Flat Screws M4x4mm SUS
(Fixed Torque Needed: 5.5 kg)

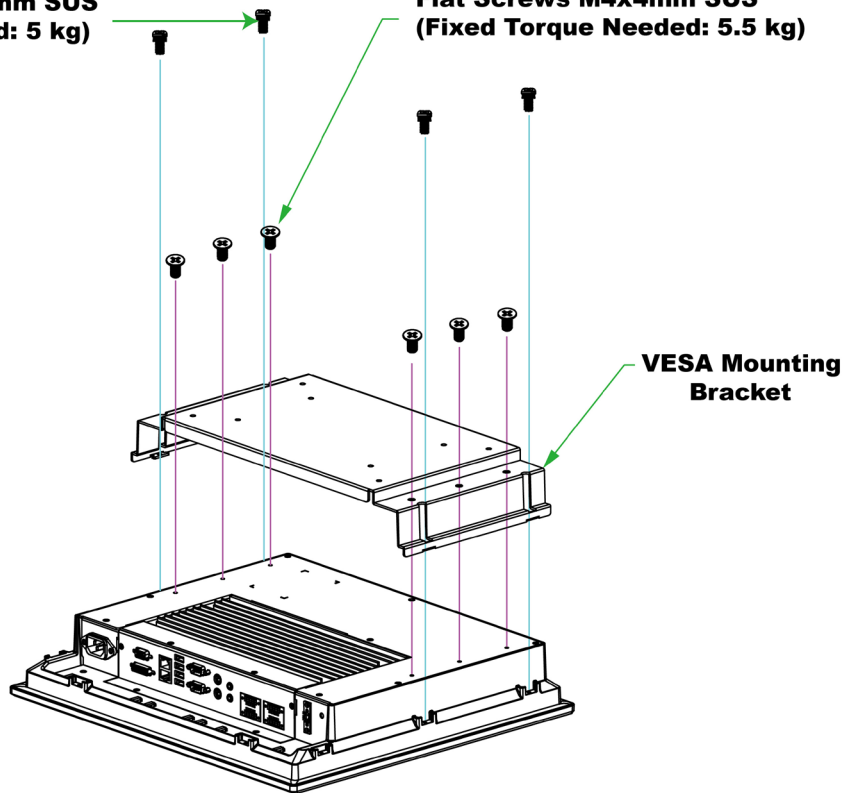

An additional four screws (not included in the kit) are required to mount the computer on a VESA rack. For this purpose, use M6 screws with a length between 10 and 12 mm.

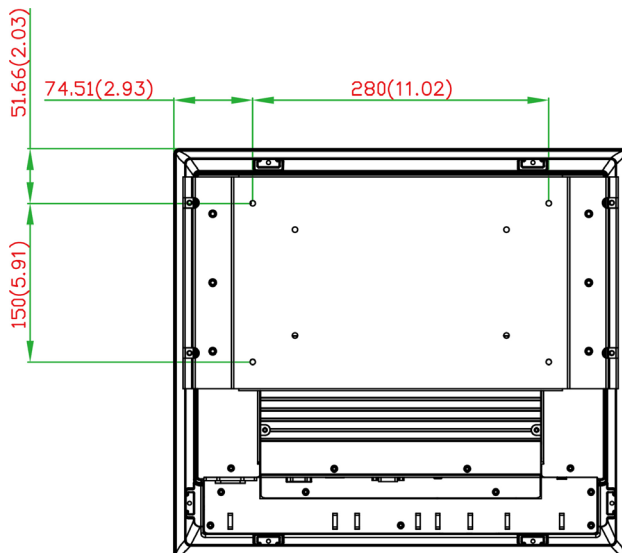

VESA Mounting Kit
4 M6 10 to 12 mm deep mounting holes

Wiring Requirements

This section describes how to connect peripheral devices to the panel computer.

You should read and follow these common safety precautions before proceeding with the installation of any electronic device:

- Use separate paths to route wiring for power and devices. If power wiring and device wiring paths must cross, make sure the wires are perpendicular at the intersection point.

NOTE Do not run signal or communication wiring together with power wiring in the same wire conduit. To avoid interference, wires with different signal characteristics should be routed separately.

- Use the type of signal transmitted through a wire to determine which wires should be kept separate. The rule of thumb is that wiring that shares similar electrical characteristics can be bundled together.
- Keep input wiring and output wiring separate.
- It is advisable to label the wiring to all devices in the system.



ATTENTION

Safety First!

Be sure to disconnect the power cord before installing and/or wiring your MPC-2190 Series.

Wiring Caution!

Calculate the maximum possible current in each power wire and common wire. Observe all electrical codes dictating the maximum current allowable for each wire size.

If the current goes above the maximum ratings, the wiring could overheat, causing serious damage to your equipment.

Temperature Requirements

Be careful when handling the unit. When the unit is plugged in, the internal components generate heat, and consequently the outer casing may feel hot to the touch.

We recommend taking the following precautions to minimize heat build-up within the display:

- Position the display within $\pm 40^\circ$ of the vertical.
- Install an external fan to increase airflow upwards through the display if (a) the display is not positioned within $\pm 40^\circ$ of the vertical, (b) the ambient temperature exceeds 25°C , or (c) the display is used in a location with minimal ventilation.

Important Safety Precaution

Even though the display is rated to operate within the IEC 60945 standard of -15 to 55°C for marine applications, it is best to ensure that the ambient temperature does not exceed 25°C . Doing so will increase the life of your display and minimize service costs.

Grounding the MPC-2190 Series

Before you power on the MPC-2190 Series, please ground the MPC-2190 as grounding and wire routing help limit the effects of noise due to electromagnetic interference (EMI). Run the ground connection from the ground screw to the grounding surface prior to connecting the power.



ATTENTION

This product is intended to be mounted to a well-grounded mounting surface, such as a metal panel.

Grounding: See the figure shown below for the location of the grounding connector. Connect the grounding wire to an appropriate grounded metal surface.

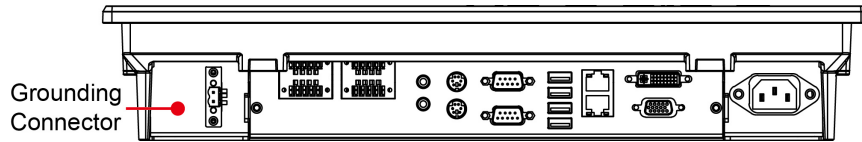

Powering on/off the MPC-2190 Series

To power on the MPC-2190 Series you may connect the **Terminal Block to Power Jack Converter** to the MPC-2190 Series DC terminal block (located on the bottom surface) and then connect a power adapter; or, alternatively, you may power the device using the AC power cord. Touch the **MENU** button (in the lower right corner of the display panel) for 1 second to turn on the computer. It takes about 10 to 30 seconds for the system to boot up.

To power off the MPC-2190 Series, touch the **MENU** button for 4 seconds; depending on your OS's power management settings you may enter **standby**, **hibernation**, or **system shutdown** mode. If you encounter technical problems, touch the **MENU** button again this time for 10 seconds to force a hard shutdown of the system.

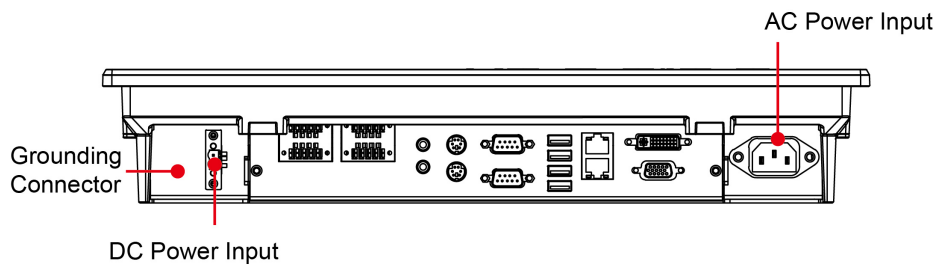

NOTE: If the MPC-2190 is powered using a DC converter the INFO dialog will display an **Error** message as the AC power status. This will not affect the MPC-2190's operation.

SavvyTouch Display Control Buttons

The MPC-2190 Series comes with five SavvyTouch display control buttons located on the front surface. These intelligent controls will light up with the your hand draws near over the area of the screen where they are located.

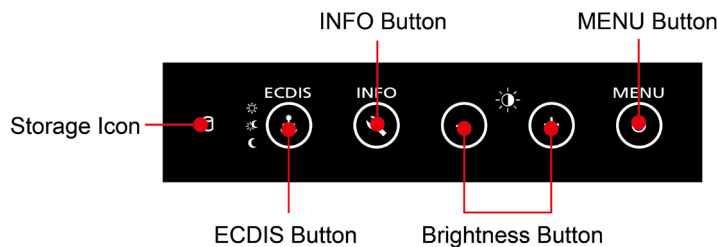

MENU

The **MENU** button operates like a power button, with which users may start up or shut down the computer. Holding the button for 1 second will power on the system, and the button will light up a solid green. To power off the MPC-2190, press and hold the **Menu** button for 4 seconds to enter **standby**, **hibernation**, or **system**

shutdown mode, depending on the power management settings you have set in your operating system. If a hard shutdown is required because of technical problems, press and hold the **Menu** button for 10 seconds to forcibly power off the system.

Brightness

Two brightness buttons are available for brightness control. Press the **+** button to increase the brightness of the panel, and the **-** button to decrease the brightness.

INFO

The **INFO** button returns the current system status for various components, such as power for AC input and main board, CPU, memory, chipset and VGA output. **Pass** will indicate that the subsystem is working well. An error message will be shown when the system is not working. CPU, memory, chipset and VGA output will be detected only at the bootup stage; any changes or failures that occur after that will not be registered by the system. The AC power and mainboard power (Main Board Power) options will be continuously detected, even after the computer has been booted up.

System Status	
AC Input Power	Pass
M / B Power	Pass
CPU	Pass
Memory	Pass
Chipset	Pass
VGA	Pass



ECDIS

Touch the button to switch between **DAY**, **DUSK**, and **NIGHT** display modes.

Upon touching the ECDIS button, the brightness configuration will be overwritten to day, dusk, or night modes.



(Storage)

A storage icon can also be found on the panel. When data access occurs, it will display a blinking red status.

NOTE The display of the MPC-2190 can also be controlled with a series of commands. For a list of the available commands and their uses, refer to **Appendix B: Display Control Interface Commands** for details

Extending the Displays

The MPC-2190 comes with both standard VGA (DB15) and DVI-D (DB24) interfaces on the bottom surface. They may be used simultaneously to extend the display across two monitors. See the following figures and tables for the location and pin assignments for the display outputs.

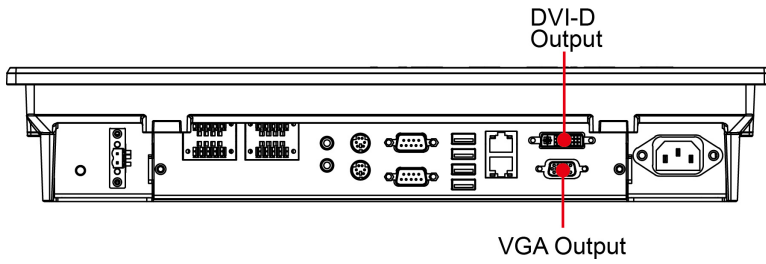

DB15 Female Connector

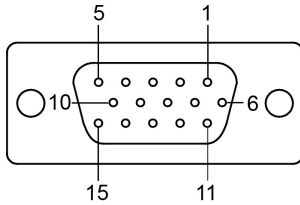

Pin No.	Signal Definition	Pin No.	Signal Definition
1	Red	9	VCC
2	Green	10	GND
3	Blue	11	NC
4	NC	12	DDC2B Data
5	GND	13	HSYNC
6	GND	14	VSYNC
7	GND	15	DDC2B Clock
8	GND		

DVI-D Connector

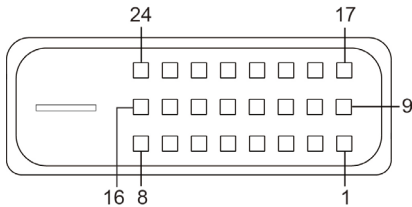

Pin	Signal Definition	Pin	Signal Definition
1	T.M.D.S. Data2-	13	N/C
2	T.M.D.S. Data2+	14	+5V Power
3	T.M.D.S. Data2 Shield	15	Ground (return for +5V, HSync, and VSync)
4	N/C	16	Hot Plug Detect
5	N/C	17	T.M.D.S. Data0-
6	DDC Clock	18	T.M.D.S. Data0+
7	DDC Data	19	T.M.D.S. Data0 Shield
8	N/C	20	N/C
9	T.M.D.S. Data1-	21	N/C
10	T.M.D.S. Data1+	22	T.M.D.S. Clock Shield
11	T.M.D.S. Data1 Shield	23	T.M.D.S. Clock+
12	N/C	24	T.M.D.S. Clock-

Connecting Data Transmission Cables

This section describes how to connect the MPC-2190 panel computer to a network, or serial devices.

Connecting to a Network

Plug an Ethernet cable into the MPC-2190’s Ethernet port. The other end of the cable should be plugged into your Ethernet network. When the cable is properly connected, the LEDs on the panel computer’s Ethernet port will glow to indicate a valid connection. See the following figure for the location of the Ethernet ports.

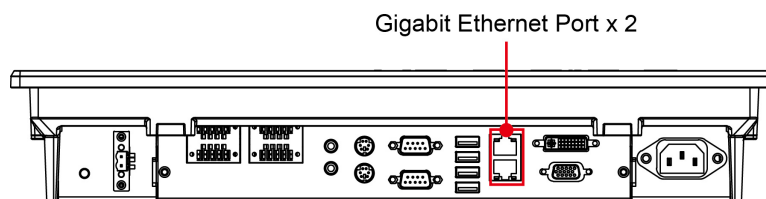

The 10/100/1000 Mbps Ethernet LAN port uses 8-pin RJ45 connectors. The following diagram shows the pinouts and the descriptions for these ports.

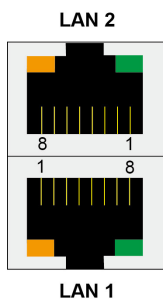

LAN (on connectors)	Green	100 Mbps Ethernet mode
	Yellow	1000 Mbps (Gigabit) Ethernet mode
	Off	No activity or 10 Mbps Ethernet mode

Pin	100 Mbps	1000 Mbps
1	ETx+	TRD(0)+
2	ETx-	TRD(0)-
3	ERx+	TRD(1)+
4	-	TRD(2)+
5	-	TRD(2)-
6	ERx-	TRD(1)-
7	-	TRD(3)+
8	-	TRD(3)-

Connecting to a Serial Device

Use a serial cable to plug your serial device into the MPC-2190's serial port. Serial ports 1 and 2 have male DB9 connectors and can be configured for RS-232, RS-422, or RS-485 communication by software. See the following figure for the location of the serial ports.

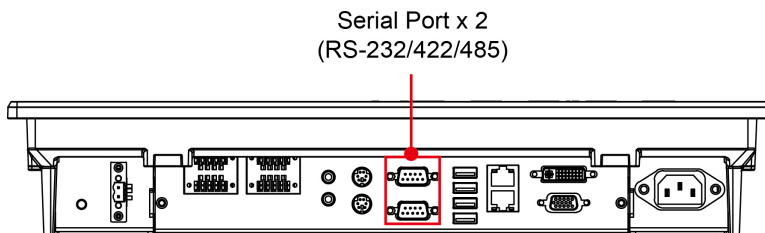

The pin assignments are shown in the table at the top of the next page:

DB9 Male Port

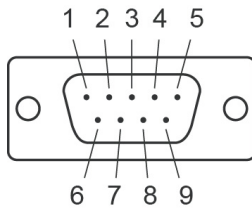

RS-232/422/485 Pinouts

Pin	RS-232	RS-422	RS-485 (4-wire)	RS-485 (2-wire)
1	DCD	TxDA(-)	TxDA(-)	-
2	RxD	TxDB(+)	TxDB(+)	-
3	TxD	RxDB(+)	RxDB(+)	DataB(+)
4	DTR	RxDA(-)	RxDA(-)	DataA(-)
5	GND	GND	GND	GND
6	DSR	-	-	-
7	RTS	-	-	-
8	CTS	-	-	-

Configuring RS-232/422/485 Serial Ports

For configuring the RS-232/422/485 serial port, please go to the following path and find the configuration example.

For the Windows 32-bit platform:

<Software DVD>\example\MPC-2190\Release\UartMode

For the Windows 64-bit platform

<Software DVD>\example\MPC-2190\x64\Release\UartMode

Select **1** to get the current UART mode; select **2** to configure the UART mode.

```

Administrator: C:\Windows\system32\cmd.exe - UartMode.exe
Microsoft Windows [Version 6.1.7601]
Copyright (c) 2010 Microsoft Corporation. All rights reserved.

C:\Users\moxa>cd\
C:\>d:
D:\>UartMode.exe
Serial Interface Test Program
  <0> Exit Program
  <1> Display Serial Interface
  <2> Set Serial Interface
1
COM1 = RS232
COM2 = RS232
  
```

Enter the port number you want to configure, and then enter the mode. For RS-232 mode, enter **0**; for RS-485-2W mode, enter **1**, for RS-422/RS-485-4W mode, enter **1**.

```

Administrator: C:\Windows\system32\cmd.exe - UartMode.exe
Microsoft Windows [Version 6.1.7601]
Copyright (c) 2010 Microsoft Corporation. All rights reserved.

C:\Users\moxa>cd\
C:\>d:
D:\>UartMode.exe
Serial Interface Test Program
  <0> Exit Program
  <1> Display Serial Interface
  <2> Set Serial Interface
2
Input the Port Number <1 ~ 2> =
1
Input the value <0:RS232, 1:RS485-2W, 2:RS422/RS485-4W > = 1
Set serial interface success!
1
COM1 = RS485-2W
COM2 = RS232
  
```

Connecting to NMEA 0183 Devices

The MPC-2190 comes with eight NMEA 0183 ports on the bottom surface. Check the following figures for the location of these ports and the pin assignments.

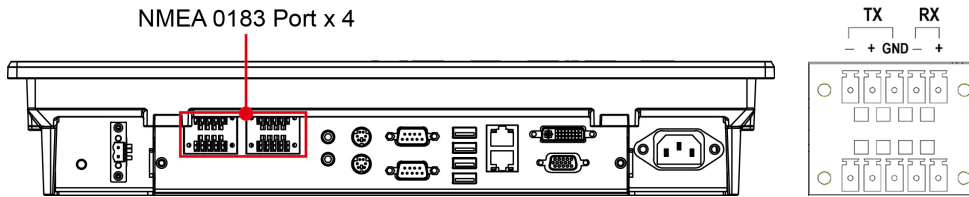

Connecting to a Speaker or a Headphone

The MPC-2190 comes with line-in and line-out interfaces for connecting a microphone and either speakers or headphones. See the following figure for the location.

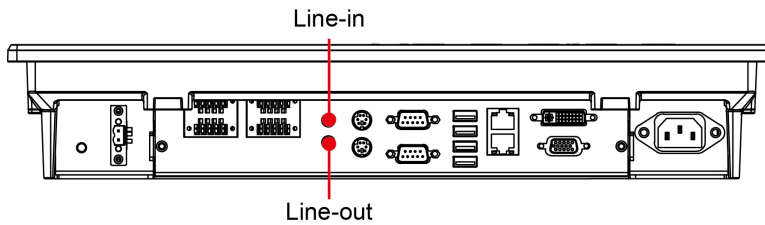

Connecting a PS/2 Keyboard and Mouse

Your MCP-2190 computer comes with two PS/2 connectors to connect to a PS/2 keyboard (upper connector) and PS/2 mouse (lower connector). See the following figure for the locations.

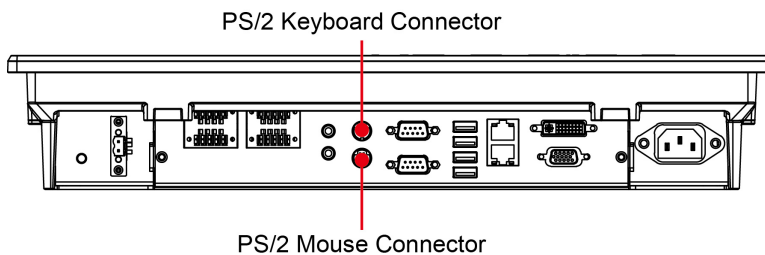

Connecting to USB Devices

The MPC-2190 comes with 4 USB 2.0 ports on the computer. The ports can be used for an external flash disk or hard drive for data storage expansion. You can also use these USB ports to connect to a keyboard or a mouse.

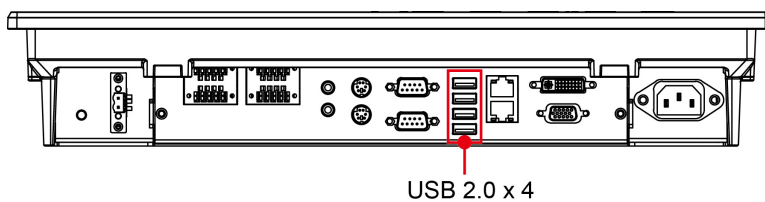

Installing a SATA HDD or SSD

The MPC-2190 has an optional HDD/SSD installation kit. To install the 2.5-inch SATA storage, follow these instructions. For better system reliability, we suggest you use a solid state disk (SSD).

1. Remove the seven screws on the back of the MPC-2190.

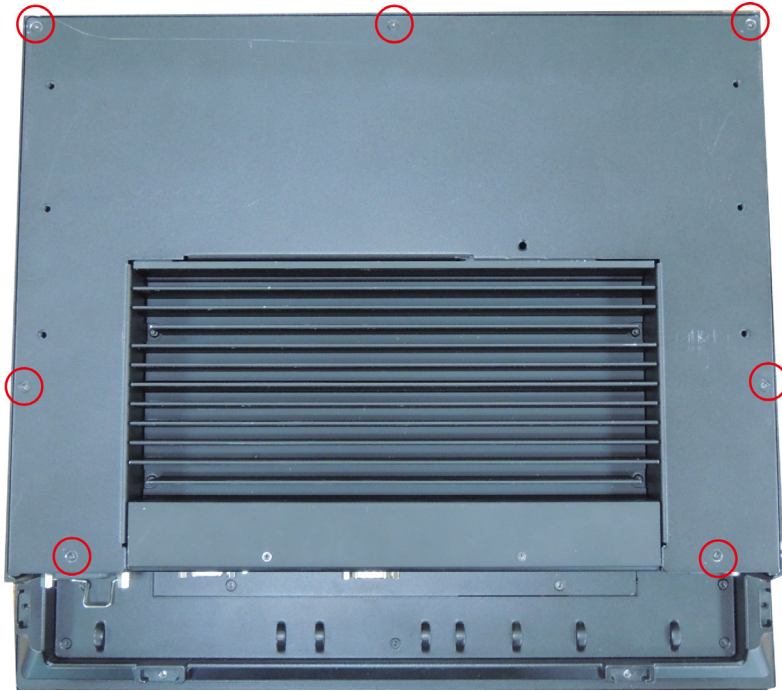

2. Remove the back cover of the MPC-2190, and find the installation area.

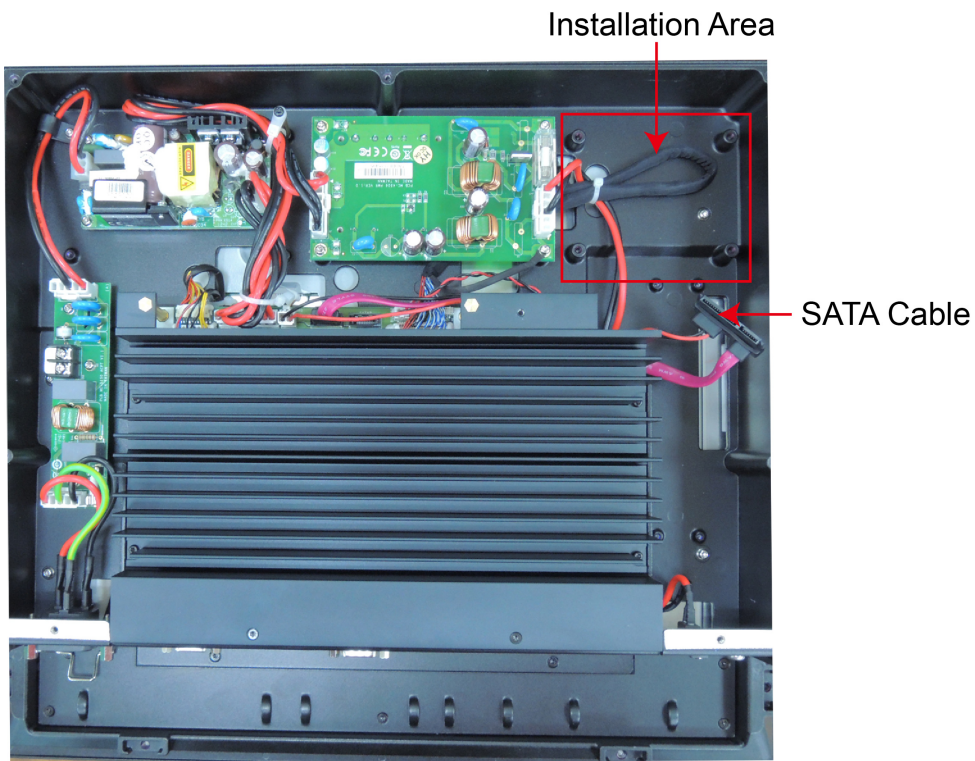

3. Install the HDD or SSD into the bracket, and fasten four screws onto two sides of the bracket.

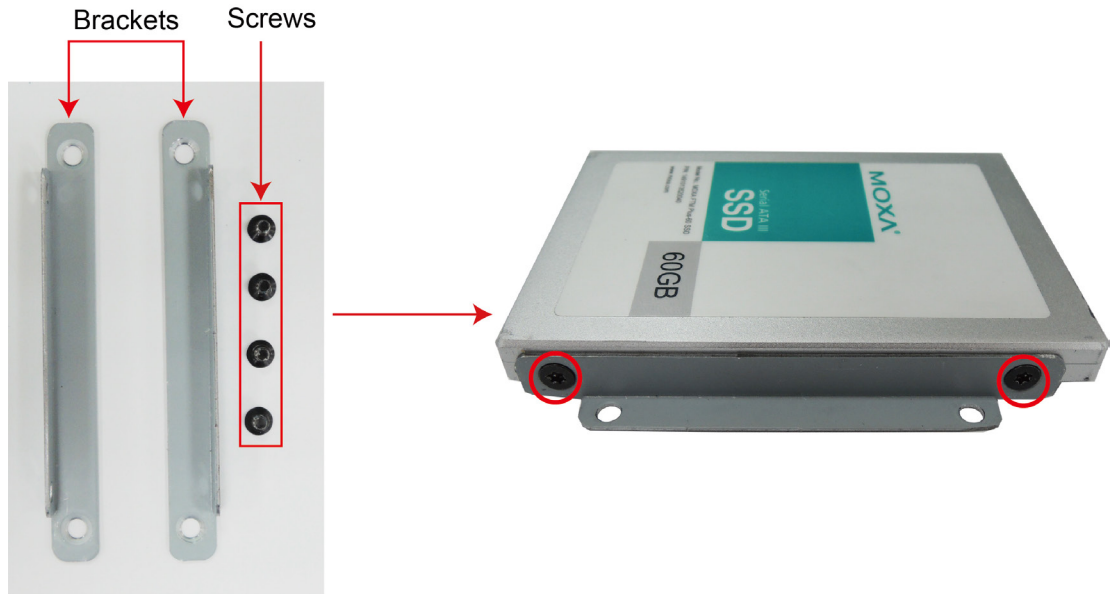

4. Place the HDD or SSD into the installation area inside the MPC-2190. Fasten the four bracket screws (shown below, in the red circles), and connect the SATA cable to the HDD or SSD.



5. Replace the cover of the MPC-2190, and fasten the screws to finish.

NOTE For fastening the screws on the cover of the MPC-2190 panel computer, we suggest you use the T10 Trox (Star) screwdriver with a torque of 4.5kg.

Display Resolution and Touch Calibration

This chapter describes how to install the VGA driver and the touch driver for the touchscreen models. After installing the drivers, you may use the tools described below to adjust the display resolution and the touch response of your panel computer.

The following topics are covered in this chapter:

- ❑ **Installing the VGA Driver**
- ❑ **Adjusting Display Resolution**
- ❑ **Installing the Touchscreen Driver**
- ❑ **Screen Calibration**

Installing the VGA Driver

The MPC-2190 comes with a stock VGA driver for Windows Embedded Standard 7. Follow these steps to install.

1. On the product CD go to the **Driver** folder and select **Win7**. Select either **32-bit** or **64-bit**, according to your platform, then select **2.VGA** folder.

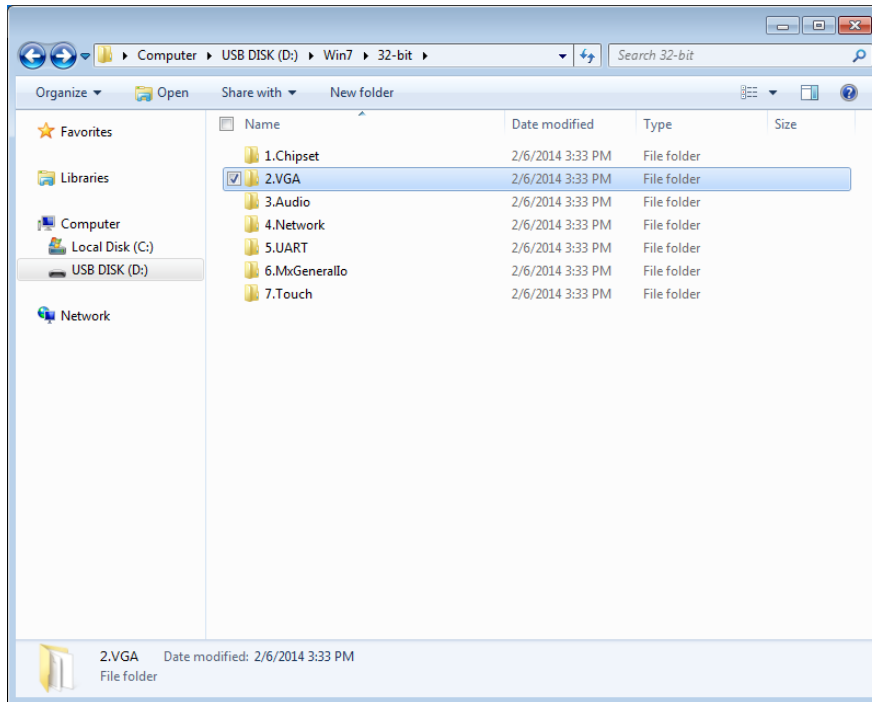

2. Double-click **Win32_15319** to continue.

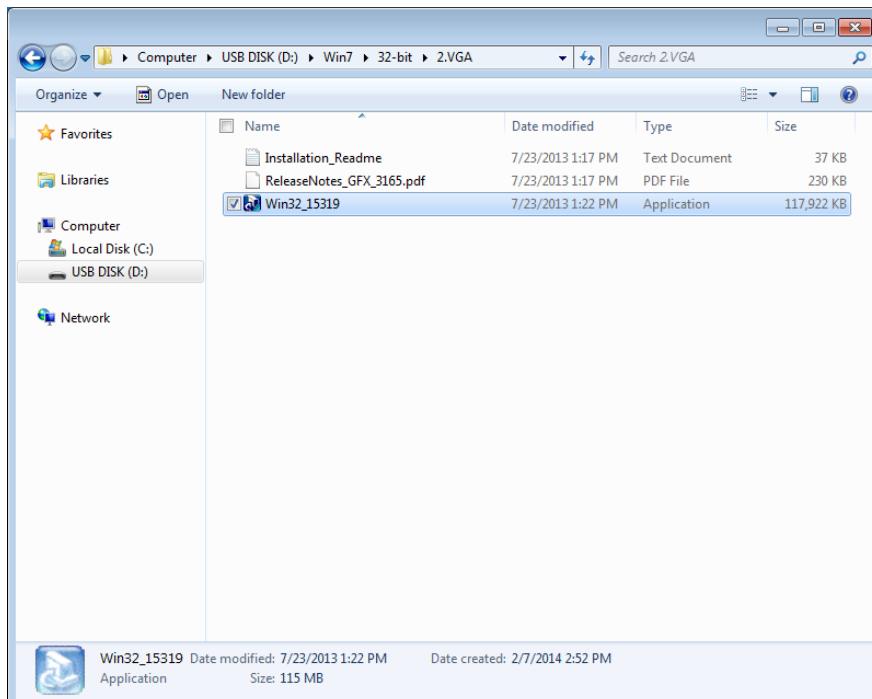

- The installation wizard will be launched; click **Next** to continue.

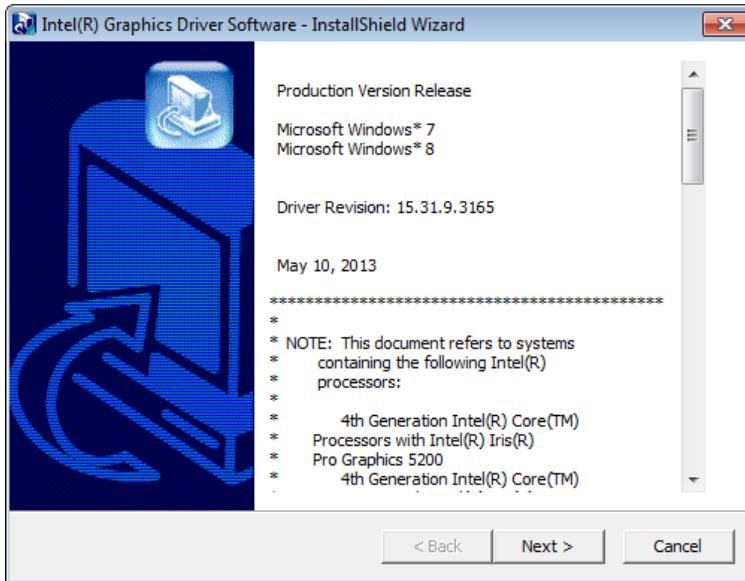

- Click **Next** to start the installation.



- Click **Yes** to accept the license agreement.

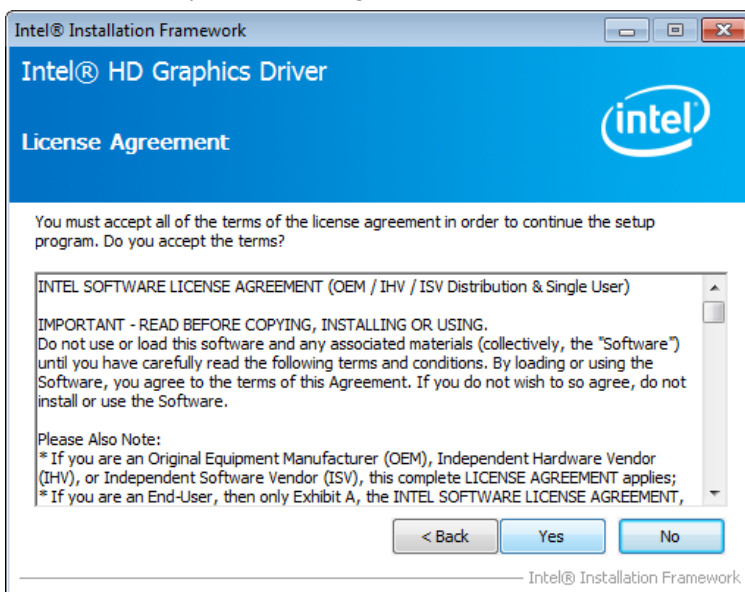

6. Click **Next** to continue.

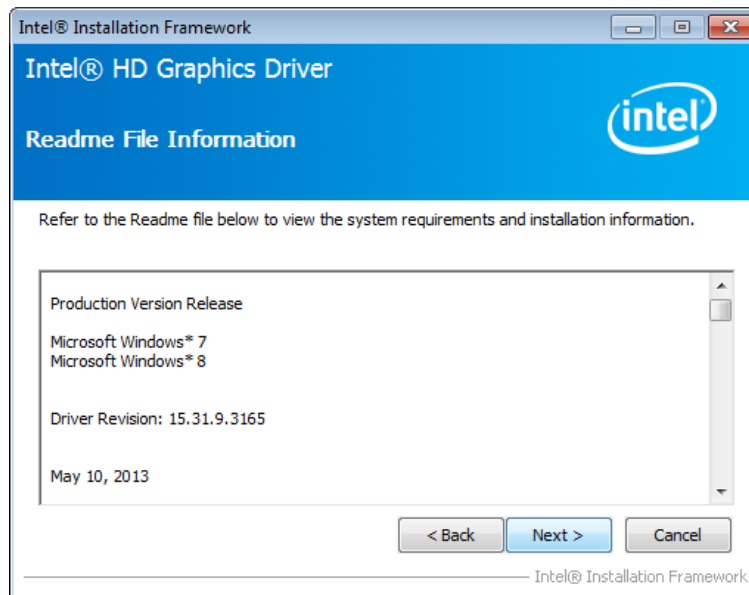

7. The installation will begin. Wait until it finishes.

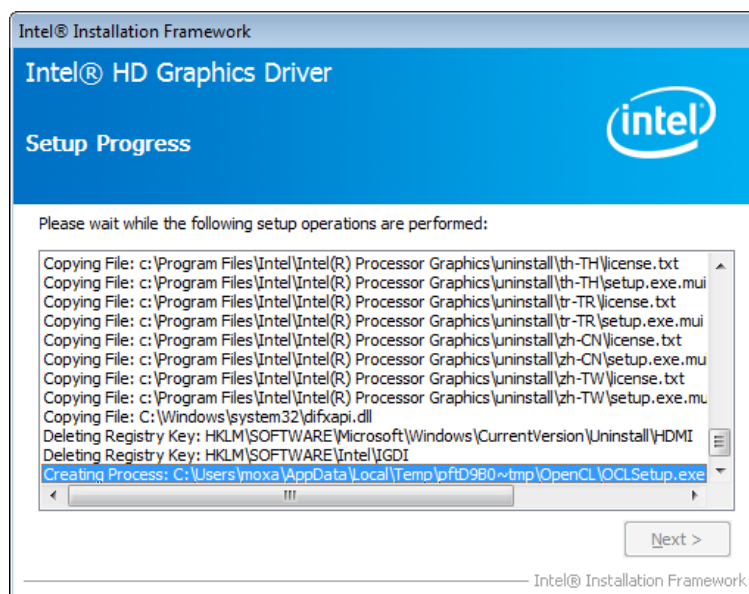
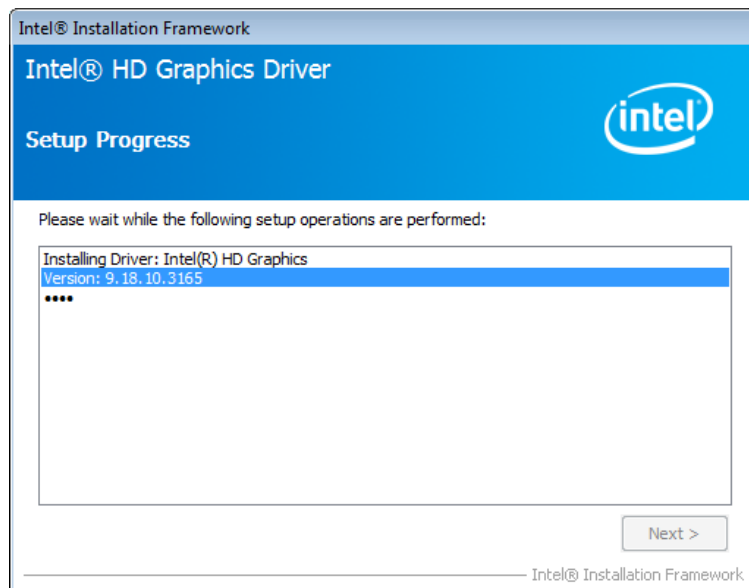

8. Click **Next** to continue.

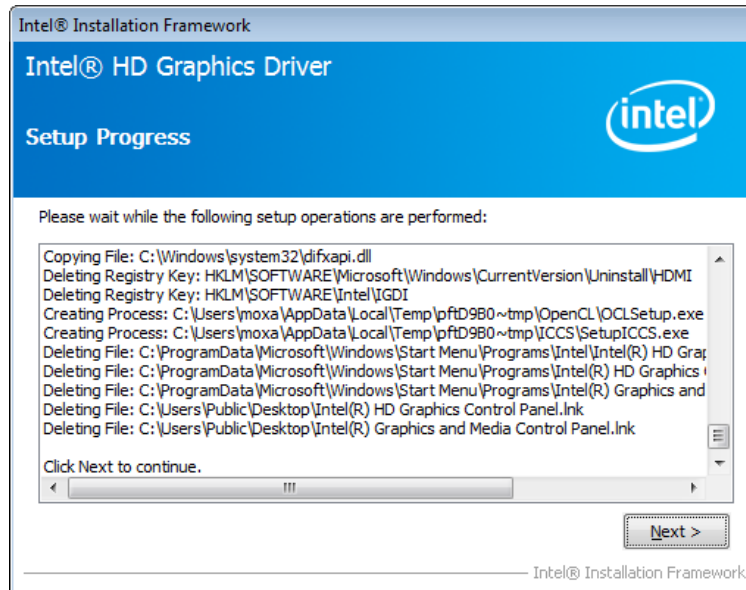

9. Select **Yes**, and then click **Finish** to complete the VGA driver installation.



10. The MPC-2190 will restart, and you may now adjust the display resolution with the tool provided by Intel.

Adjusting Display Resolution

Follow these steps to adjust the display resolution.

1. Right-click the Intel HD Graphics Control Panel icon on the right down corner of the screen, and select **Graphics Properties**.



2. Select **Display**.

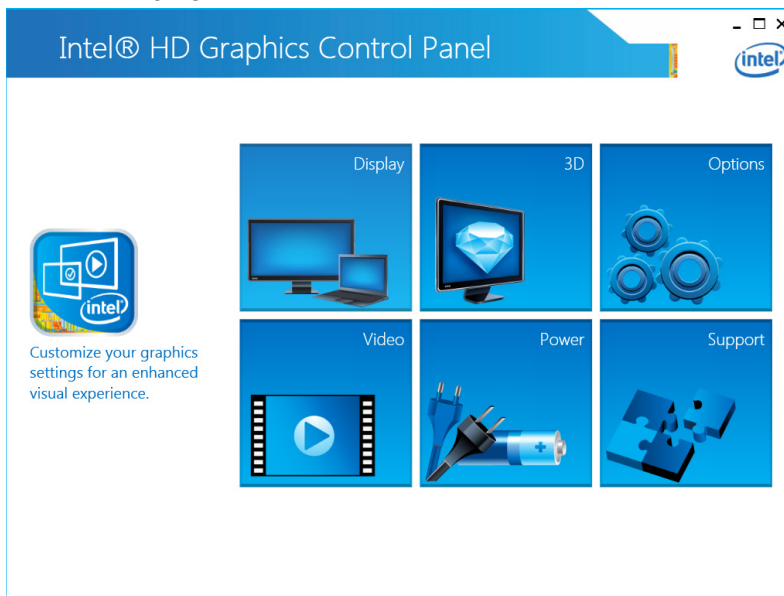

3. You can now adjust the resolution, refresh rate, and the display rotation. Select **Maintain Display Scaling**, to maximize the display so it fits the screen. Click **Apply** when finished.

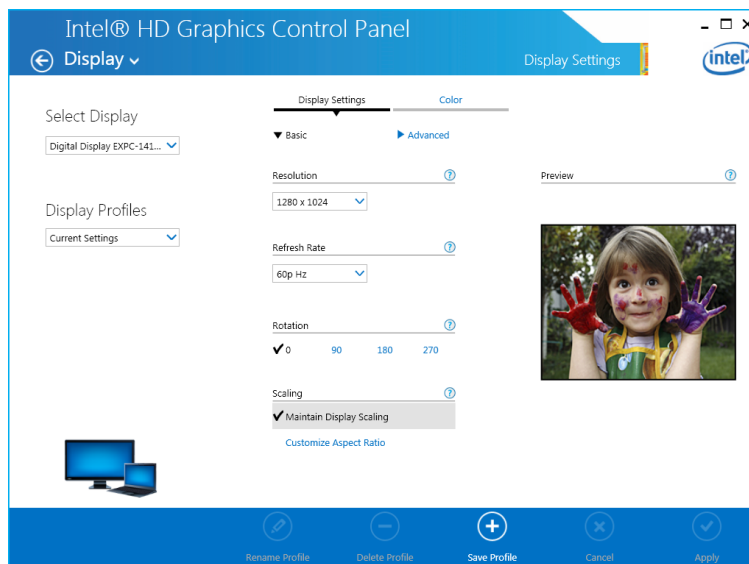

- If you want to adjust the display size, select **Customize Aspect Ratio**, and adjust by pulling the bars on the right.

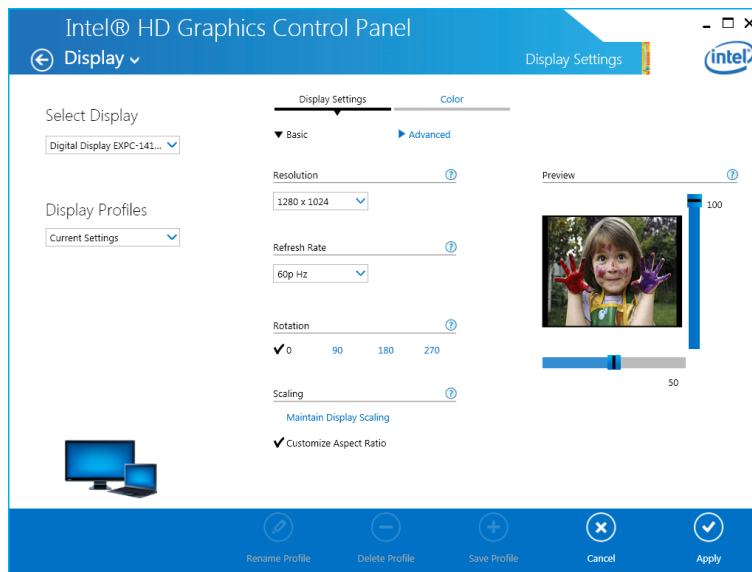

- Click **Apply** when finished.

Installing the Touchscreen Driver

For touchscreen models, you need to install the touchscreen driver. Follow these steps.

- In the Driver folder, select **7.Touch** folder.

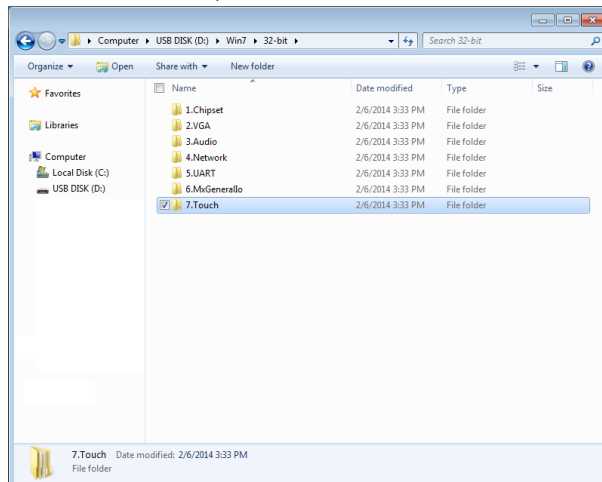

- Select **eGalaxTouch_7_Vista_XP_2K_5.11.0.9126** folder.

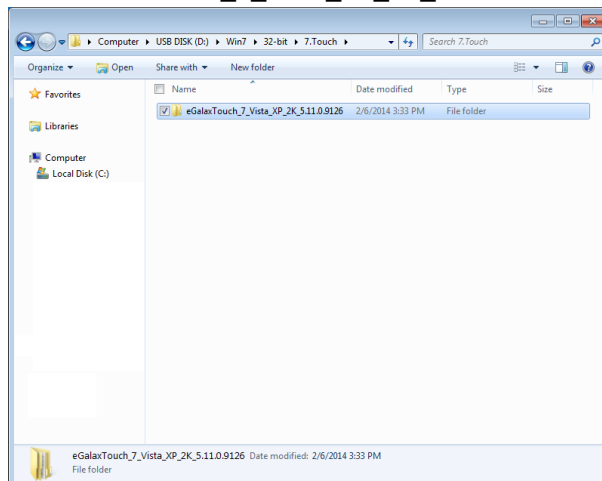

3. Select **eGalaxTouch_5.11.0.9126** folder.

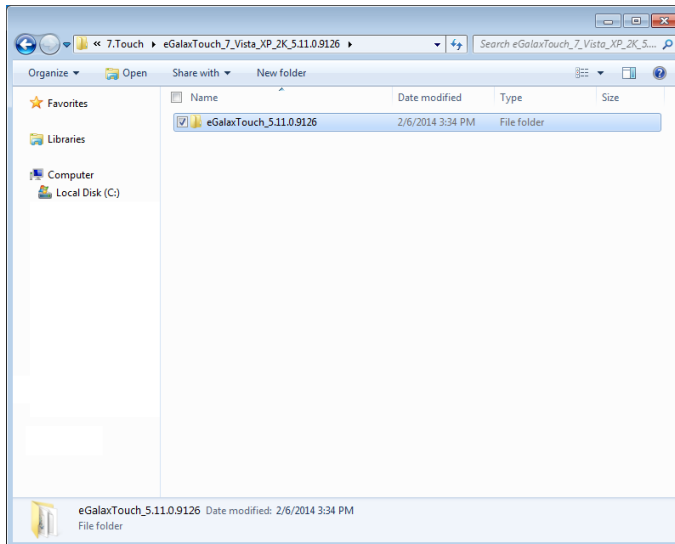

4. Select **setup** in the folder for the installation.

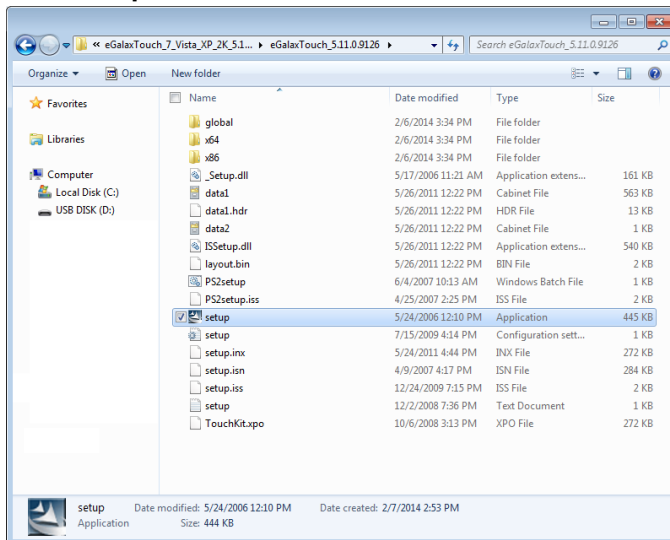

5. Click **Next** to continue.

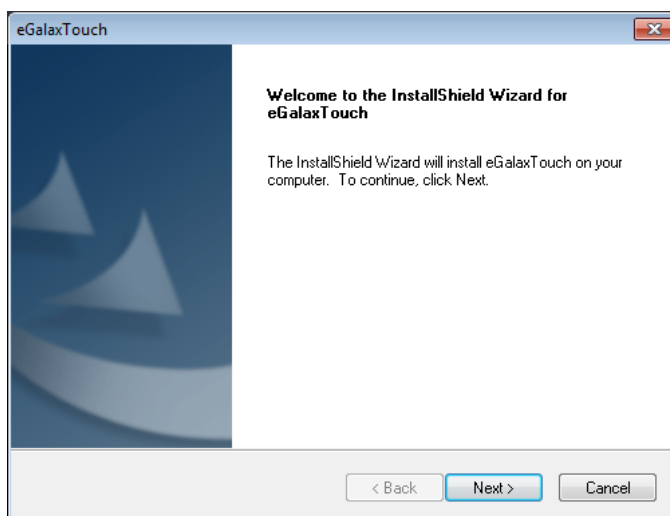

6. You do not need to check Install PS/2 interface drive. Click **Next** to continue.

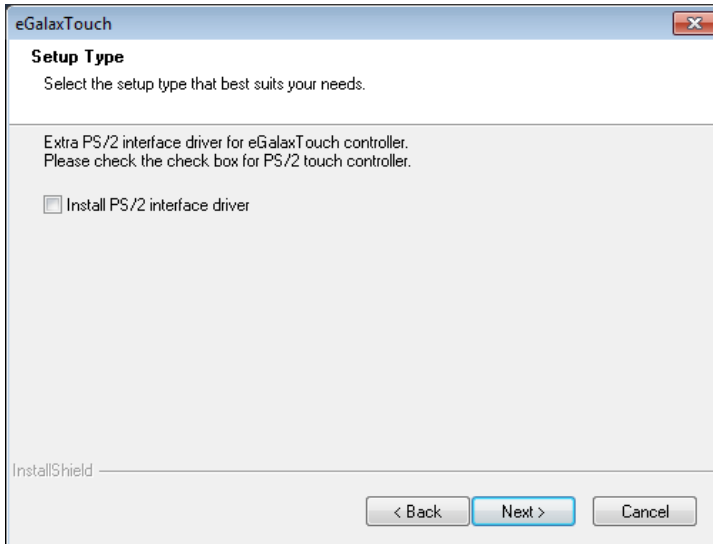

7. Check **Install RS232 interface drive**. Click **Next** to continue.

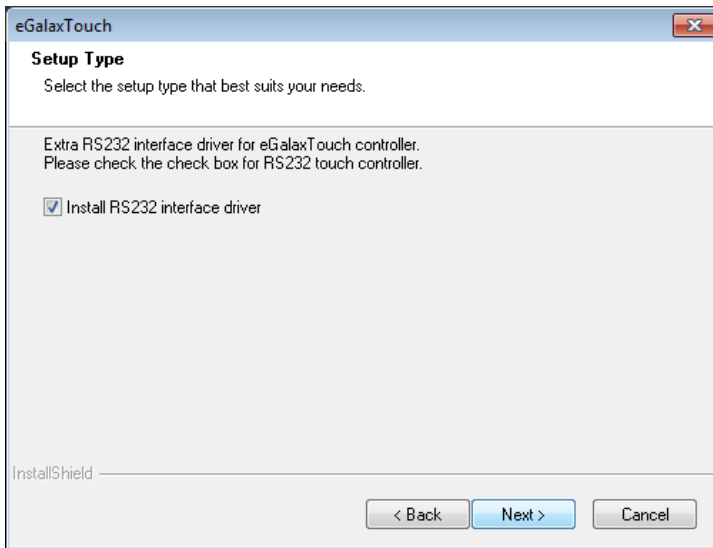

8. You may select the time to do touch screen calibration and then click **Next** to continue.

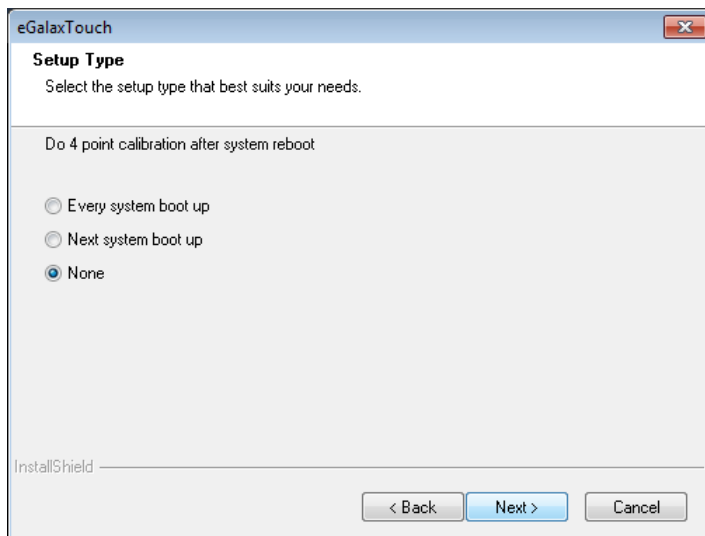

9. If you want this computer to be a touchscreen interface, click **OK** to continue.

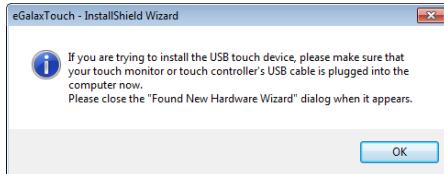

10. You may check **Support Multi-Monitor System**, and then click **Next** to continue.

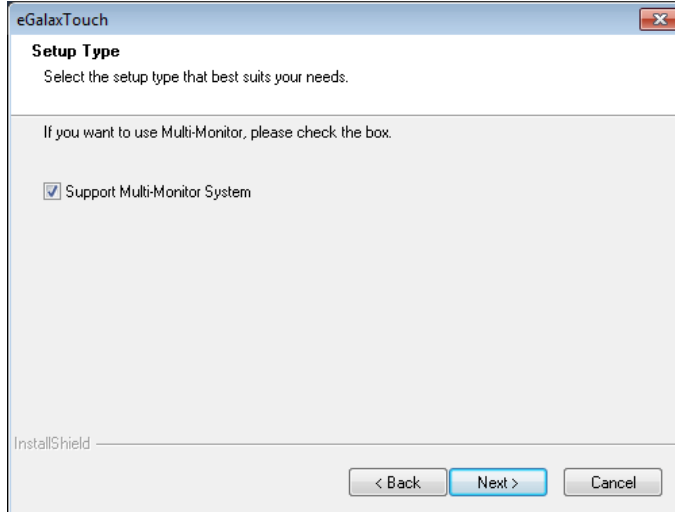

11. You may select the destination folder by clicking **Browse**, and then click **Next**.

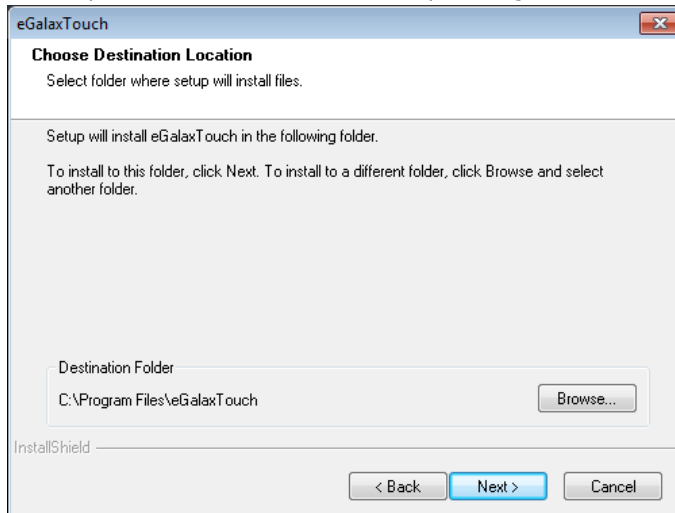

12. Click **Next** to continue.

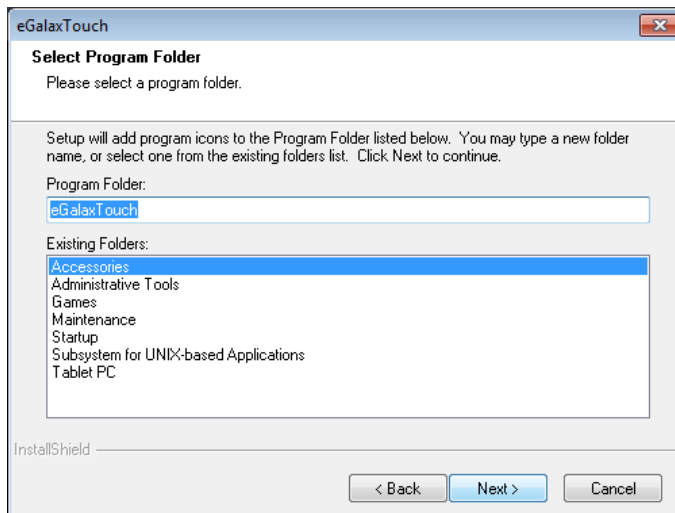

13. You may **Create an eGalaxTouch Utility shortcut on desktop** by clicking the appropriate box. Click **Next** to continue.

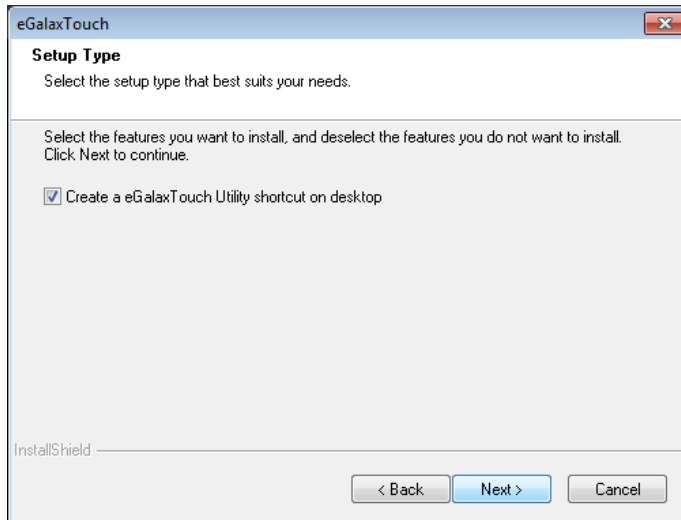

14. The installation will start, and wait until it finishes.

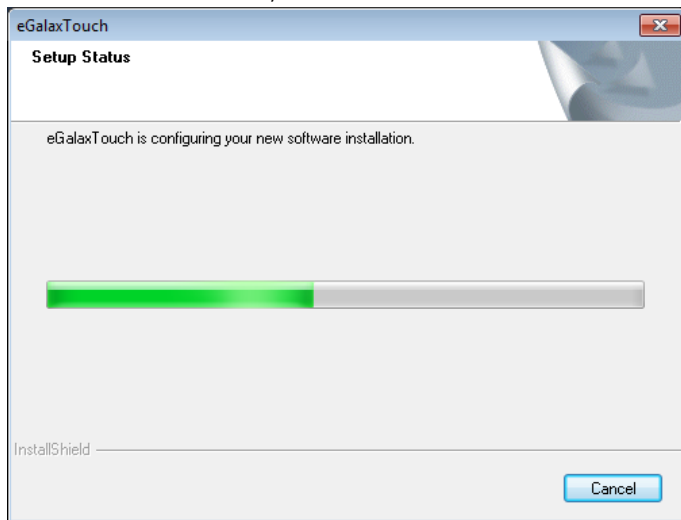

15. When finished, click **Yes**. You can do the 4 point calibration for the touch function.

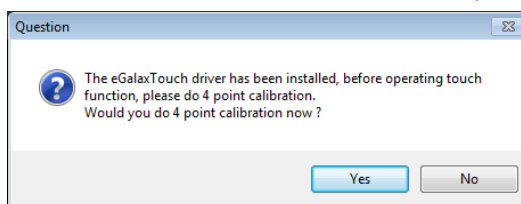

16. Click the circle in the corner until it shows **OK!**

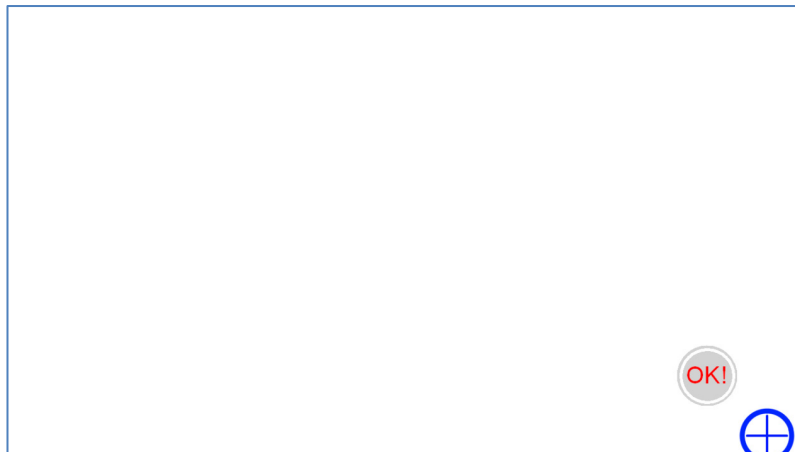

17. Click **OK** to complete.

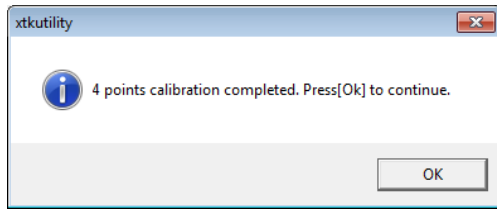

Screen Calibration

Please note that you need to do 4 point calibration whenever you change the display resolution, to maintain touchscreen accuracy. Follow these steps.

1. Run **eGalaxTouch** by double-clicking the icon on the desktop.



2. Select **Tools** tab, and click **4 Points Calibration** item.

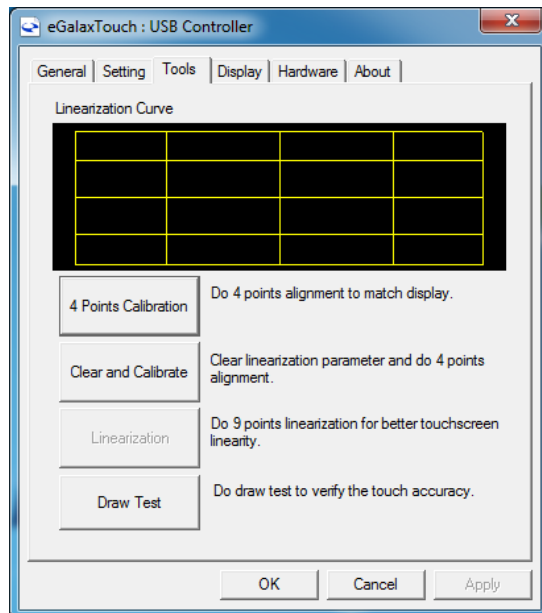

3. Click the circle in the corner until it shows **OK**.

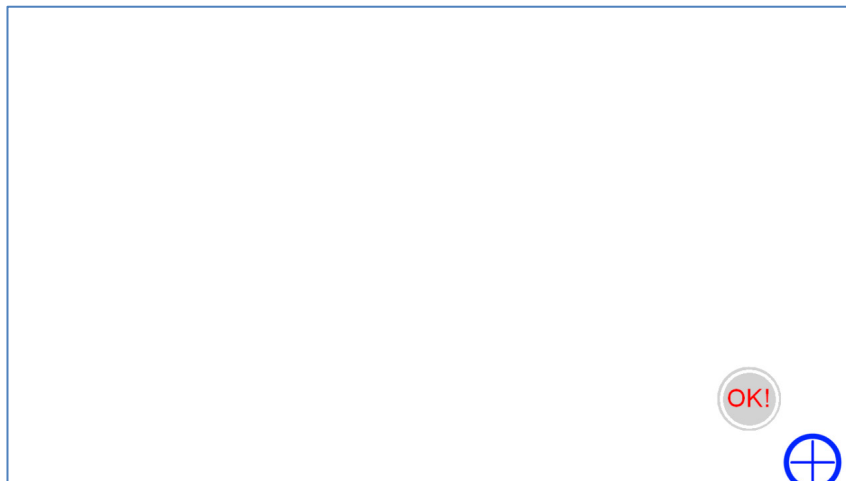

4. Click **OK** to complete.

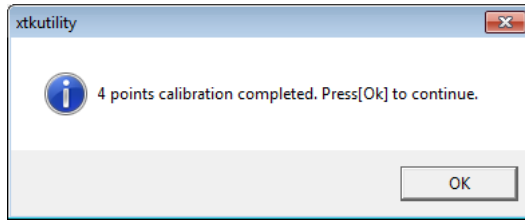

BIOS Setup

This chapter describes the BIOS settings of the MPC-2190 Series computer. The BIOS is a set of input/output control routines for peripherals. The BIOS is used to initialize basic peripherals and helps boot the operating system before the operating system is loaded. The BIOS setup allows the user to modify the system configurations of these basic input/output peripherals. All of the configurations will be stored in the battery backed up CMOS RAM, which retains the system information after system reboots or the power is removed.

The following topics are covered in this chapter:

- ❑ **Entering the BIOS Setup Utility**

- ❑ **Main Information**

- ❑ **Advanced Settings**

- Boot Configuration
- HDC Configuration
- Video Configuration
- Chipset Configuration
- Hardware Monitor

- ❑ **Security Settings**

- Set Supervisor Password

- ❑ **Power Settings**

- ❑ **Boot Settings**

- Boot Type
- EFI Device First
- Boot Delay Time
- Legacy

- ❑ **Exit Settings**

- Exit Saving Changes
- Save Change Without Exit
- Exit Discarding Changes
- Load Optimal Defaults
- Load Custom Defaults
- Save Custom Defaults
- Discard Changes

- ❑ **Upgrading the BIOS**

Entering the BIOS Setup Utility

To enter the BIOS setup utility, press the "F2" key while the system is booting up. The main **BIOS Setup** screen will appear. Select **SCU** to enter the **BIOS configuration**.



NOTE The projected capacitive touch screen function is not supported in BIOS, connect a keyboard to the MPC-2190 for BIOS configuration.

A basic description of each function key is listed at the bottom of the screen. Refer to these descriptions to learn how to use them.

F1: General Help

F5/F6: Change Values

F9: Setup Defaults

F10: Save and Exit

↑ ↓ : **Select Item**

← → : **Select Menu**

ESC: Exit

ENTER: Select or go to Submenu.

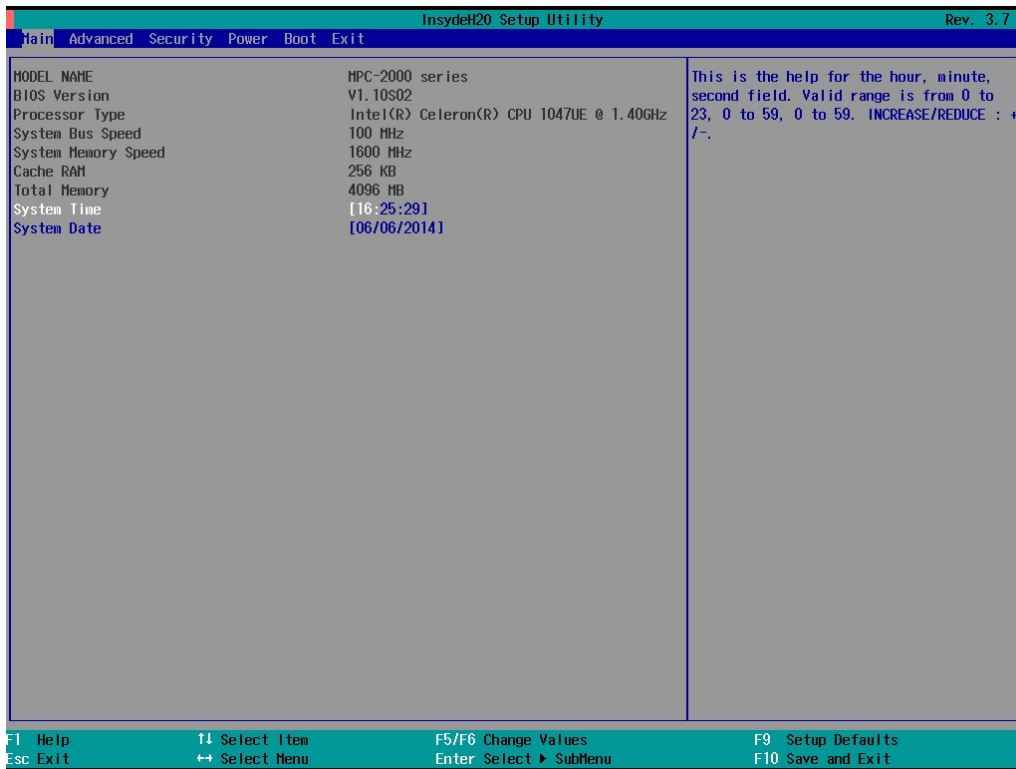

Main Information

The main page indicates the system information, such as model name, BIOS version, and CPU type. User may view the basic system hardware information in the page.

Advanced Settings

The "Advanced Features" screen will appear when choosing the "Advanced" item from the main menu.

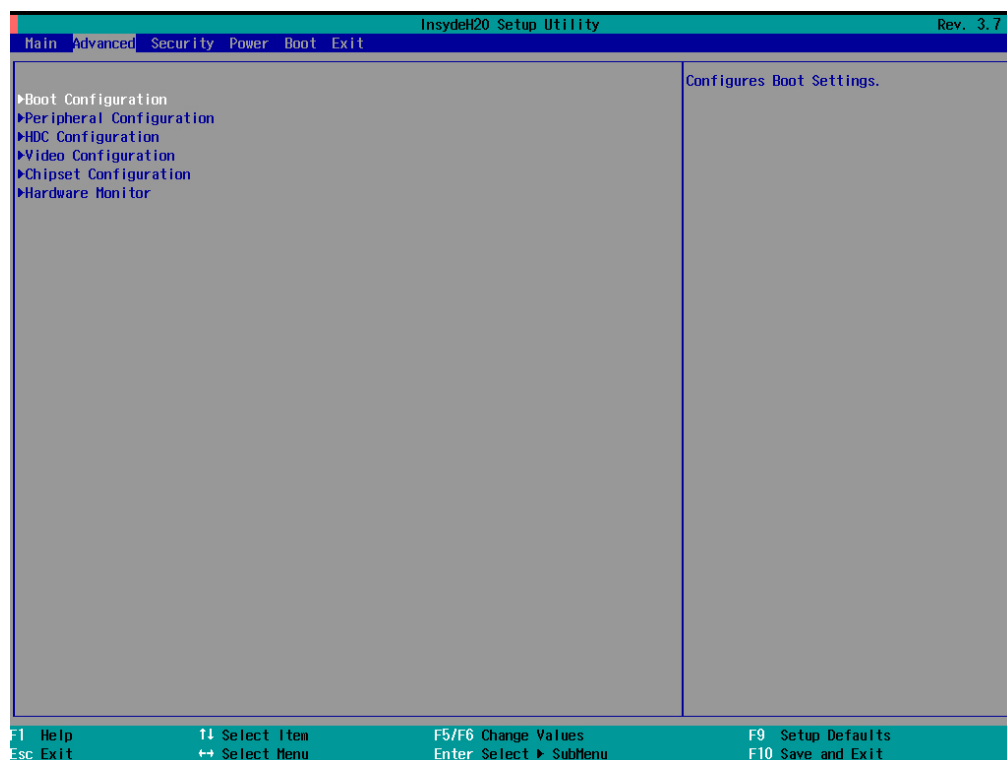

Boot Configuration

This item allows users to configure the default value of Numlock.

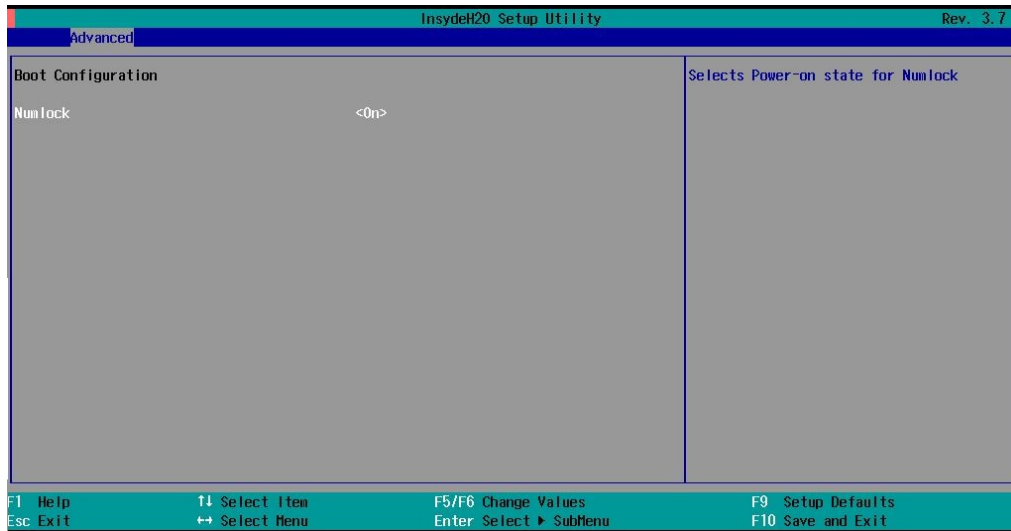

Option: On (default), Off

HDC Configuration

The host drive controller may be configured for IDE (legacy default), or AHCI mode. When the legacy IDE mode is selected, the following screen will appear.

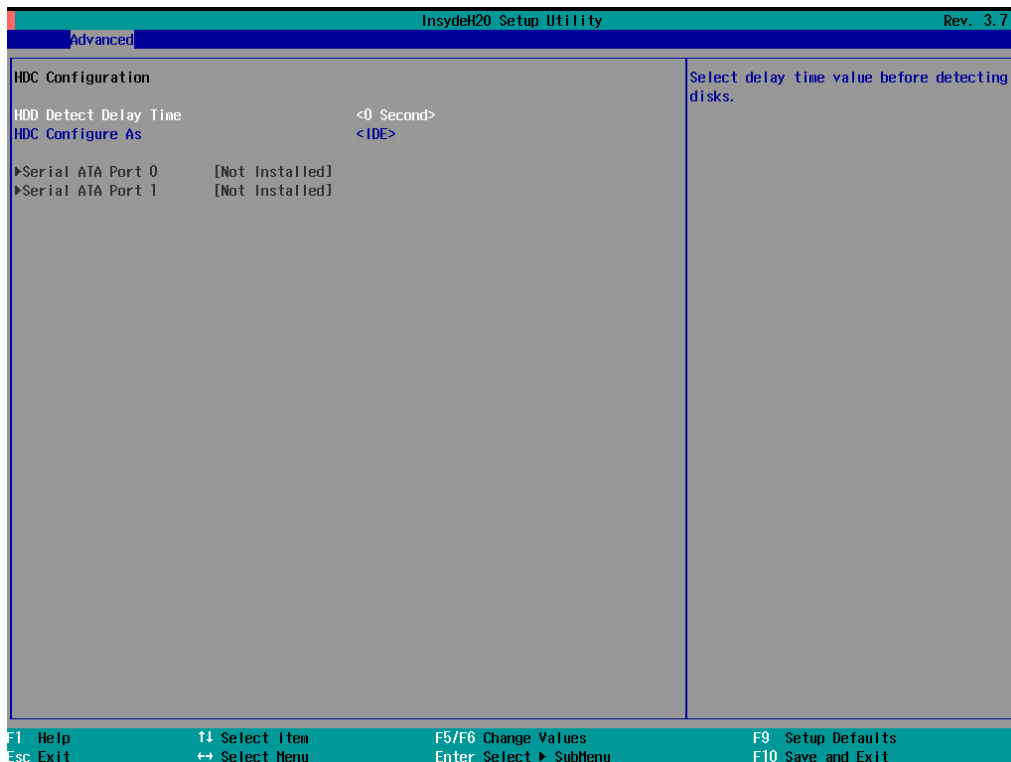

HDD Detect Delay Time

This setting allows you to configure the delaying time value before detecting the hard disks.

Option: 0 (default), 1, 2, 3 seconds.

Serial ATA Port 0 to 1

This setting allows you to display information about the installed drives.

AHCI SALP

Please note that AHCI SALP will only appear when AHCI mode is selected. This item allows you to enable **Aggressive Link Power Management** (SALP) in AHCI. SALP enables the host bus adapter to conserve power by directly detecting when a SATA drive is no longer processing information and then immediately shifting it into suspended or sleep modes without waiting for software processes to initiate power-down processes. Host Capability Register bit 26.

Options: Enabled (default), Disabled

SATA Port 0 to 1 - HotPlug

This item allows you to enable/disable hotplug capabilities (the ability to remove the drive while the computer is running) for installed storage drives.

Options: Disable (default), Enabled

Video Configuration

This item allows you to configure the integrated graphics device (IGD) for things like memory allocation (**DVMT**) and monitor types (**Boot Type**).

Internal Graphics Device

This option allows you to enable/disable the internal graphics device.

Options: Enable (default), Disable

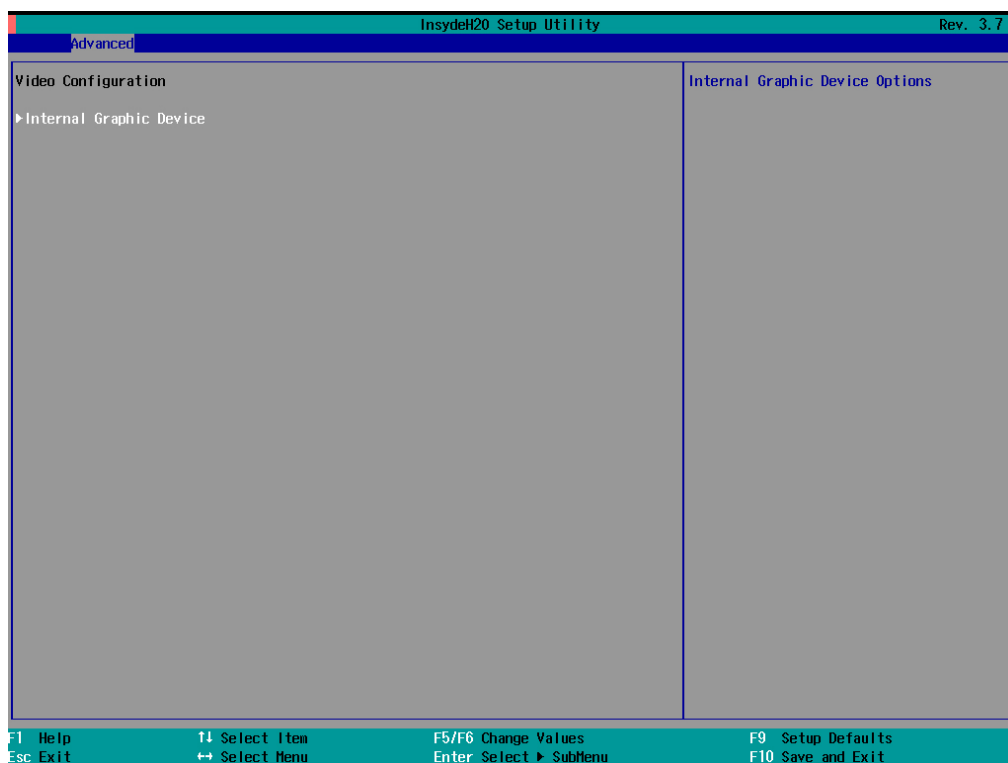

IGD—DVMT Pre-Allocated

This item allows you to configure pre-allocated memory capacity for the IGD. Pre-allocated graphics memory is invisible to the operating system.

Options: 64 MB (default), 32 MB, 96 MB, 128 MB, 256 MB, 512 MB

DVMT is a BIOS solution where the optimum amount of memory is dynamically allocated and de-allocated as needed for balanced graphics and system performance, through Intel® Direct AGP and a highly efficient memory utilization scheme. DVMT ensures the most efficient use of available system memory resources for maximum 2D/3D graphics performance.

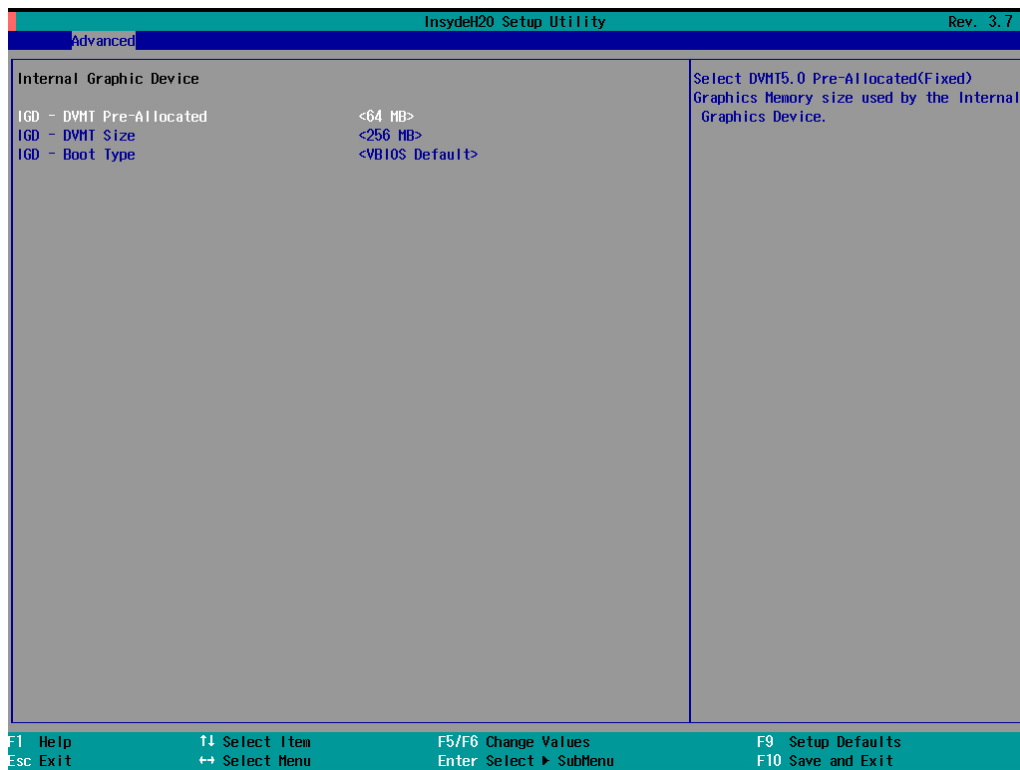

IGD—DVMT Size

This item allows you to configure the maximum amount of memory DVMT will use when allocating additional memory for the internal graphics device.

Options: 256 MB (default), 128 MB, Max

IGD – Boot Type

This item allows you to select the video device which will be activated during POST.

Options: VBIOS Default (default), VGA, DVI-D2, DVI-D1

Chipset Configuration

This item allows you to configure the chipset settings.

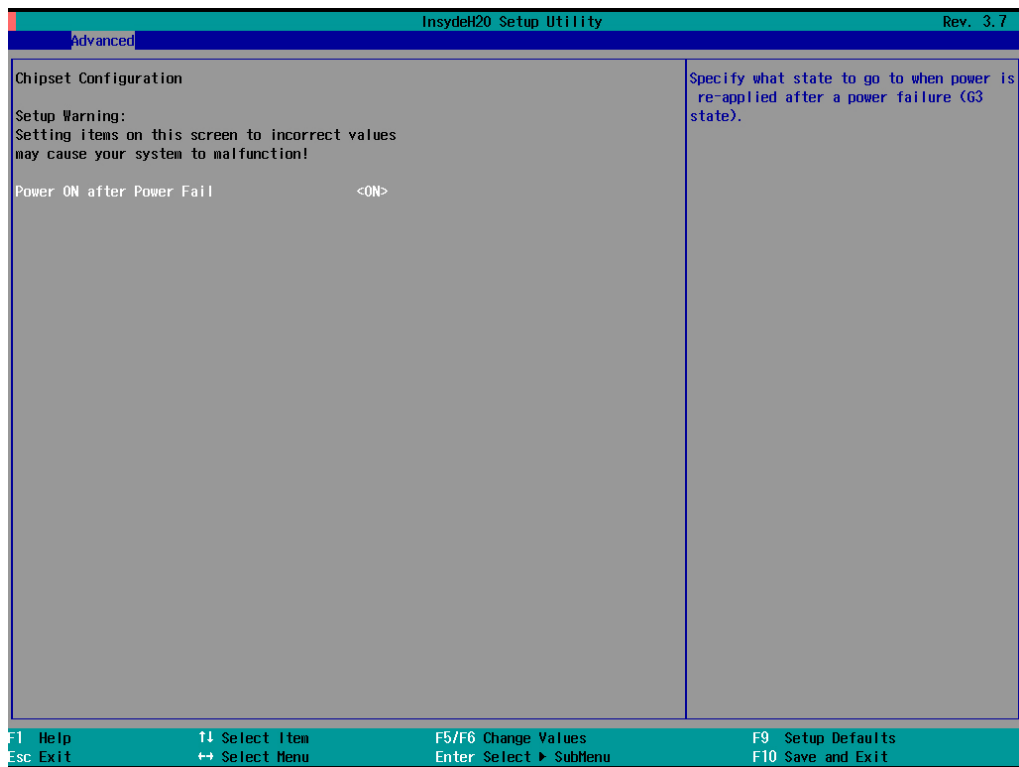

Power ON after Power Fail

This item allows you to enable/disable the computer from automatically powering up after a system crash.

Options: ON (default), OFF, Last State

Hardware Monitor

This item allows you to view stats like CPU and system temperature, voltage levels, and other chipset information.

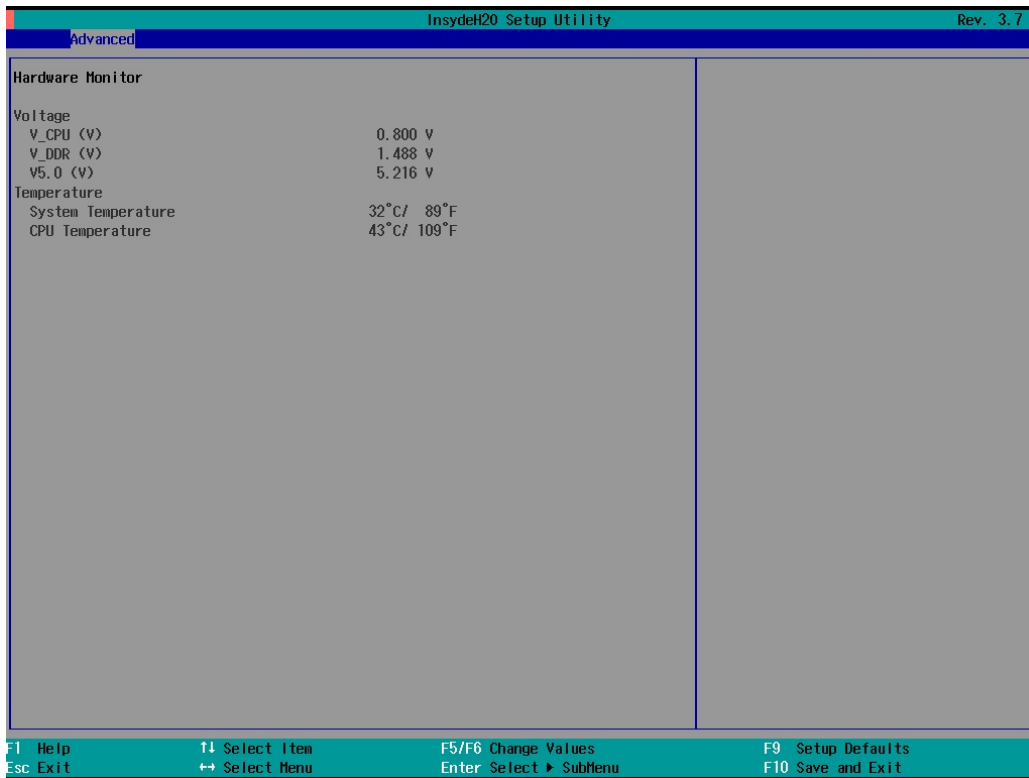

Security Settings

This section allows users to configure security settings with a supervisor password and user password.

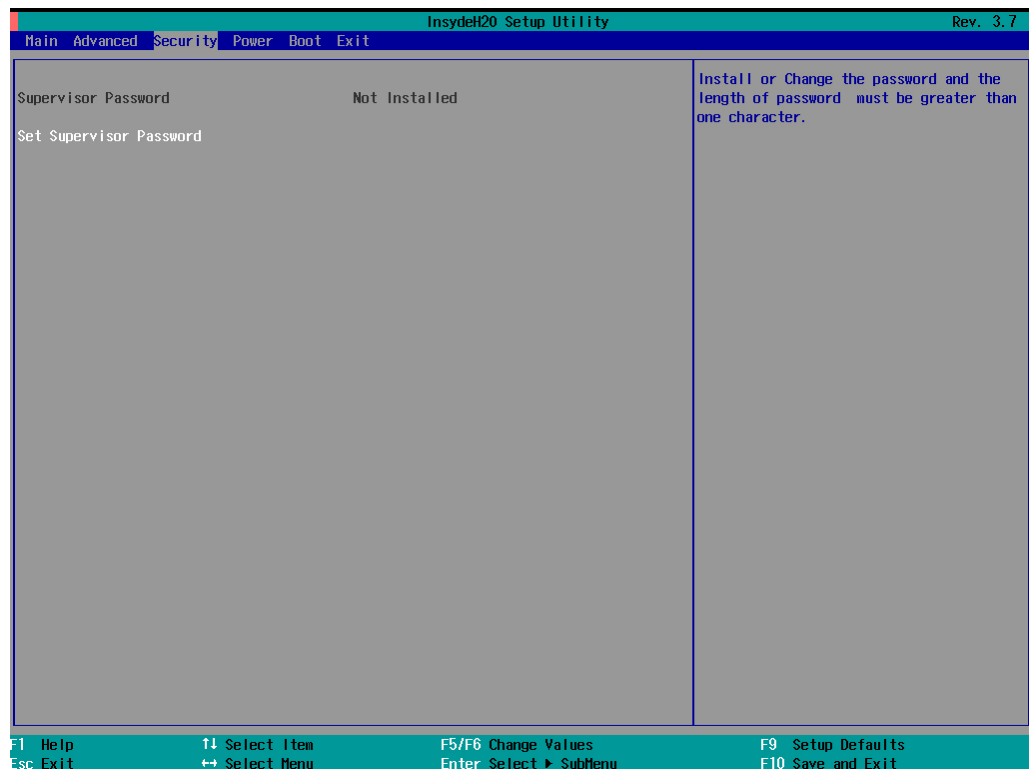

Set Supervisor Password

This item allows you set the supervisor password. Select and then enter the password, and then confirm the password again.

To delete the password, enter **Set Supervisor Password** and then enter the old password; then, leave the new password fields blank, and press enter.

Power Settings

The section allows users to configure power settings.

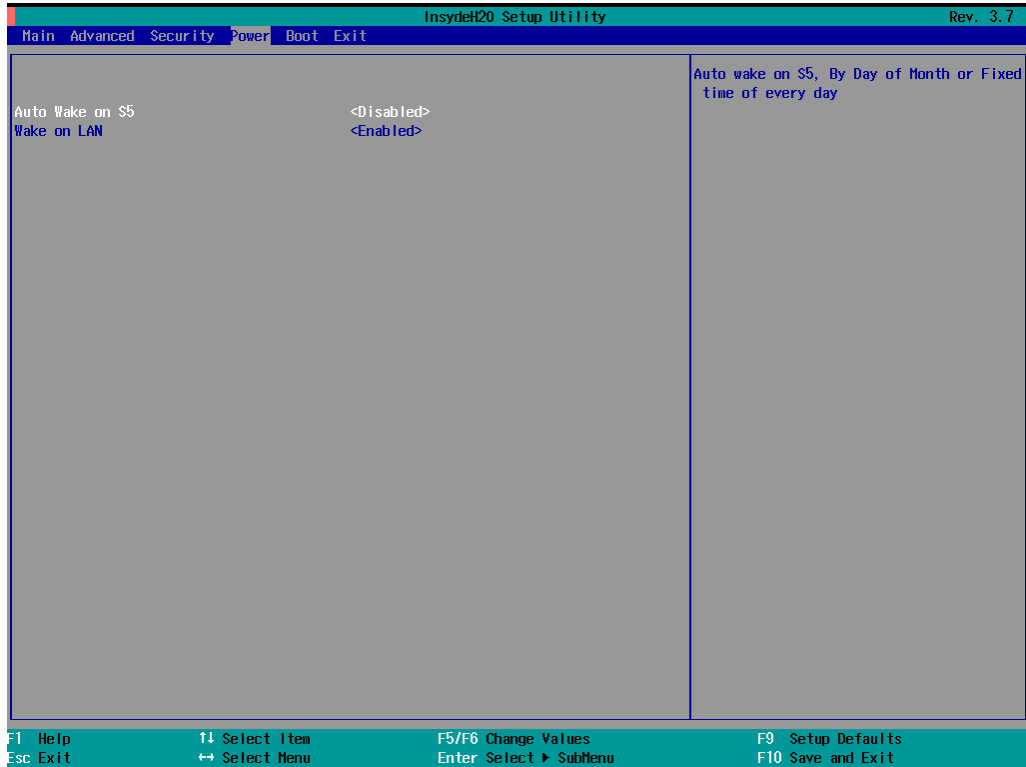

Boot Settings

The section allows users to configure boot settings.

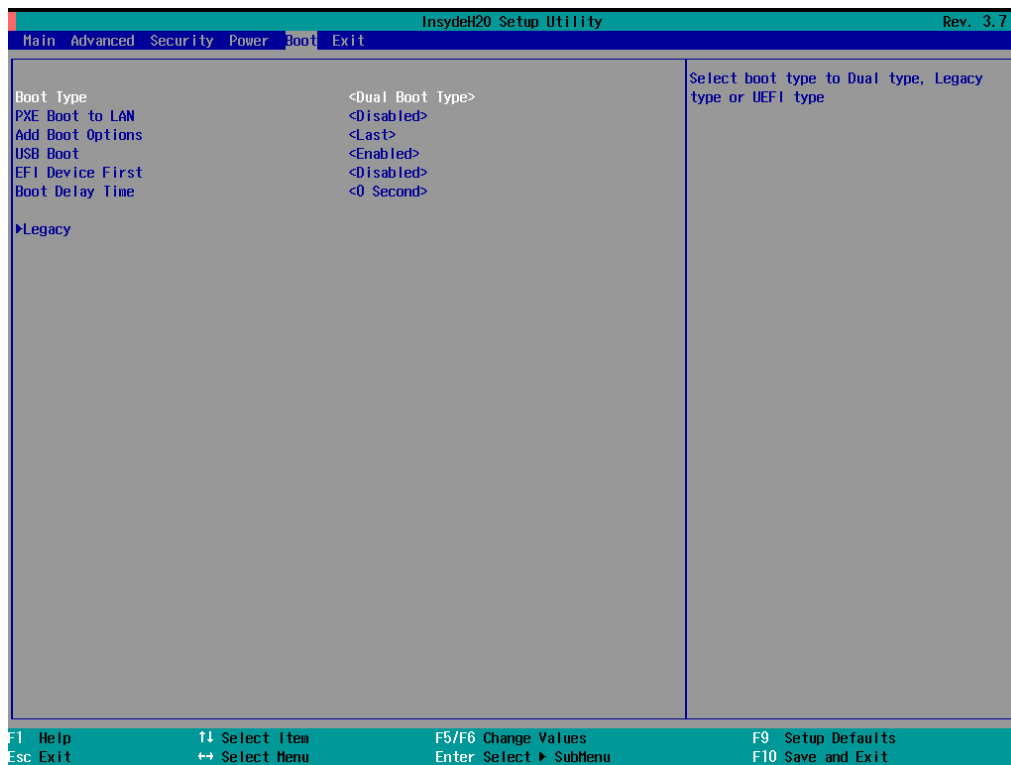

Boot Type

This item allows you to enable/disable quick boot function.

Options: Dual Boot Type (default), Legacy Boot Type, UEFI Boot Type.

PXE Boot to LAN

This item allows you to enable/disable PXE boot to LAN function.

Options: Disabled (default), Enabled

Add Boot Options

This item allows you to add the boot order options for shell, network and Removables.

Options: Last (default), First

USB Boot

This item allows you to enable/disable USB boot function..

Options: Enabled (default), Disabled

EFI Device First

This item allows you to determine EFI device first or legacy device first. If enabled, EFI device will be the first; if disabled, legacy device will be the first.

Options: Disabled (default), Enabled

Boot Delay Time

This item allows you to configure the delay time value for users to input hot key during POST time.

Options: 0 Second (default), 3 Seconds, 5 Seconds, 10 Seconds

Legacy

Normal Boot Menu

This item allows you to configure the boot menu.

Options: Normal (default), Advance

Boot Type Order

This item allows you to select the boot order. Use F5/F6 to change values.

Options: Hard Disk Drive (default), CD/DVD-ROM Drive, USB, Others

Hard Disk Drive/USB Drive

This item allows you to view installed devices such as hard disk drives, USB drives, or CD-ROMs. For example, if you have inserted a USB drive into the computer, it will appear here.

Exit Settings

The section allows users to exit the BIOS environment.



Exit Saving Changes

This item allows you to exit the BIOS environment and save the values you have just configured.

Options: Yes (default), No

Save Change Without Exit

This item allows you to save changes without exiting the BIOS environment.

Options: Yes (default), No

Exit Discarding Changes

This item allows you to exit without saving any changes that might have been made to the BIOS.

Options: Yes (default), No

Load Optimal Defaults

This item allows you to revert to the factory default BIOS values.

Options: Yes (default), No

Load Custom Defaults

This item allows you to load custom default values for the BIOS settings.

Options: Yes (default), No

Save Custom Defaults

This item allows you to save the current BIOS values as a “custom default” that may be reverted to at any time by the “load custom defaults” selection just above.

Options: Yes (default), No

Discard Changes

This item allows you to discard all settings you have just configured.

Options: Yes (default), No

Upgrading the BIOS

This section describes how to upgrade the BIOS. However, please note that it is easy to permanently damage the computer when upgrading the BIOS. We strongly recommend that you contact Moxa’s technical support staff for assistance in order to obtain all necessary tools and the most current advice before attempting to upgrade the BIOS on any Moxa device.

Step 1: Create a Bootable USB Disk

Before upgrading the BIOS every user should first create a bootable USB RAM drive as a system rescue device. You may use any software that can create a bootable USB drive. In this section, we use Rufus, which may then be downloaded and used to create a bootable RAM drive, as an example. Do the following steps to create a bootable USB disk by using Rufus.

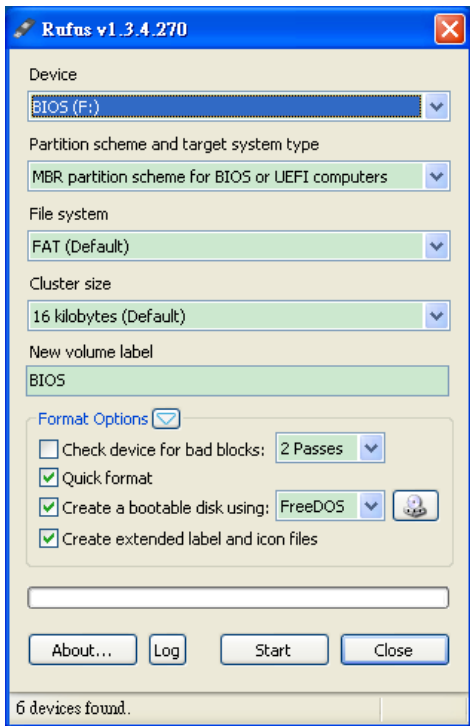
<ol style="list-style-type: none"> 1. Start the Rufus and in Device drop-down list select the USB device that you want to use as a bootable disk. 2. Select MBR partition scheme for BIOS or UEFI computers, let it can boot from legacy BIOS or UEFI. 3. Select FAT (Default) from File system drop-down list. 4. Select 16 kilobytes (Default) for Cluster size. 5. Enter a drive name in New volume label. 6. Check Quick format, Create a bootable disk using FreeDOS, and Create extended label and icon files. 7. Click Start to format and create the bootable USB drive. 	
--	--



ATTENTION

We suggest you use a USB drive with under 2 GB in disk space, as larger USB drives may not support FAT file format and consequently fail to boot.

Step 2: Prepare the Upgrade File

You must use the BIOS upgrade installation file to upgrade the BIOS. Contact Moxa's technical department for assistance.

1. Get the BIOS upgrade installation file. The file name should have following format: **200xxSx.exe** (xx refers to version numbers).
2. Copy the file to the Bootable USB Disk.

Step 3: Run the upgrade program on the MPC-2190 Series Panel Computer

1. Reboot the computer, press F2 while booting up to go to the Boot Manager
2. Select USB Disk as the first boot source. Press Enter to continue.

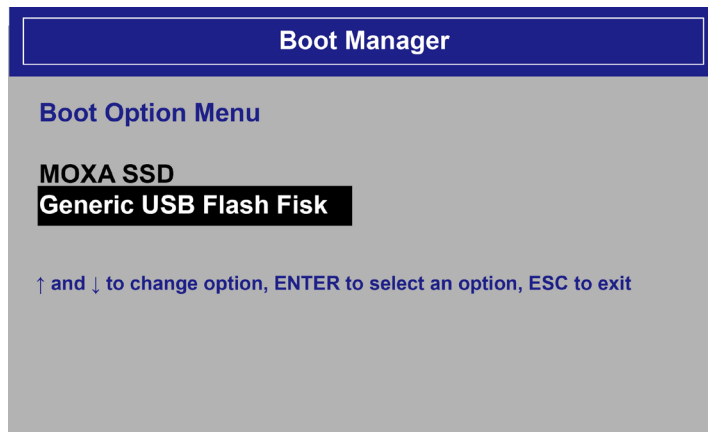

3. When boot up finishes, DOS screen will show up. Go to the directory where the upgrade file is located. For example, if the upgrade file is stored in the MPC2190 folder, type **cd MPC2190**.

```
C:\cd MPC2190
```

4. Run the upgrade program by typing **20011S02.exe**. Please note that the upgrade filename may vary depending on the versions.

```
C:\MPC2190>20011S02.exe
```

5. The upgrade program will be automatically performed. Please wait until the procedure to be finished.

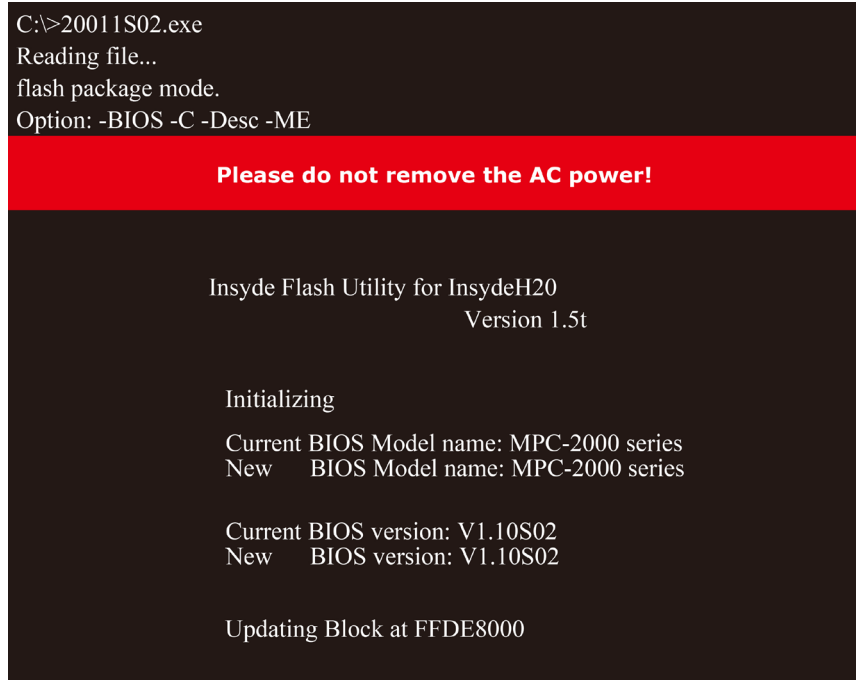

- When the upgrade is finished, the computer will automatically reboot. You may check the BIOS version in Main page of the BIOS Setup

MODEL NAME	MPC-2000 series
BIOS Version	V1.10S02
Processor Type	Intel (R) Celeron (R) CPU 1047UE @ 1.40GHz

**ATTENTION**

Do NOT switch off the power supply during the BIOS upgrade, since doing so may cause the system to crash.

Display Control Interface

This chapter describes how to use the display's control interface commands over the console.

The following topics are covered in this chapter:

- ❑ **Connecting to the Console Interface**
- ❑ **Display Control Interface Command Format**
 - Command Format Description
- ❑ **Downloading RGB Files**

Connecting to the Console Interface

If you want to use the commands in **Appendix B** to adjust the display settings, you need to connect to the display using the console interface. The following steps describe how.

The console interface is listed as the COM3 interface within the operating system. To communicate with the display over COM3, we suggest you use terminal emulator for Telnet, like Moxa's PComm.

When launching the PComm Terminal Emulator, configure the following settings:

1. Select **Port Manager**, and then select **Open**.

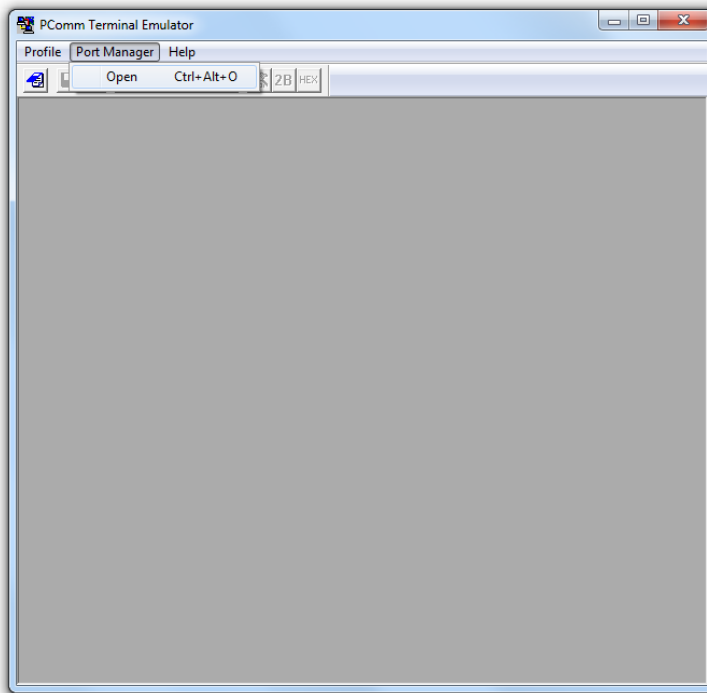

2. Configure the **Property** settings:

Protocol: Serial

Serial Parameters: COM3

Baud rate: 9600

Data bits: 8

Parity: None

Stop bits: 1

RTS state: ON

DTR state: ON

When finished, click **OK**.

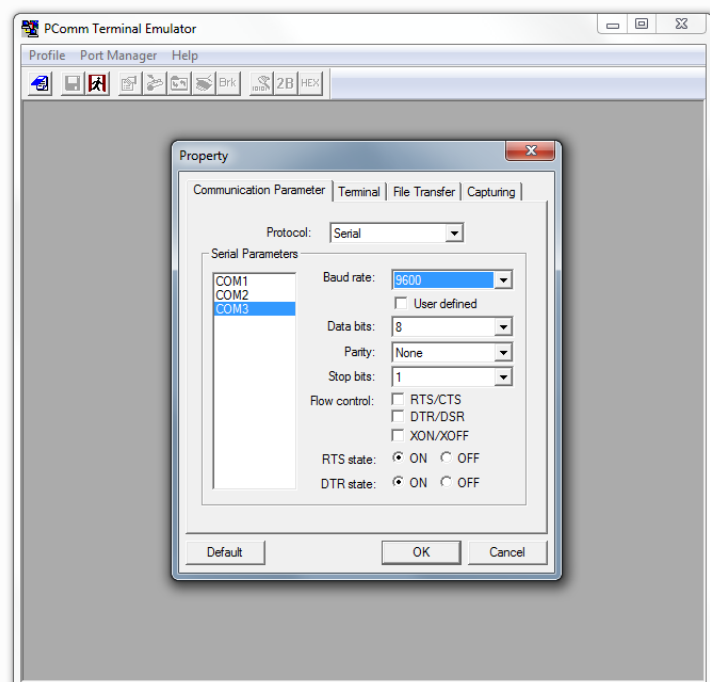

3. After successfully connecting, select the **Send pattern** tab.

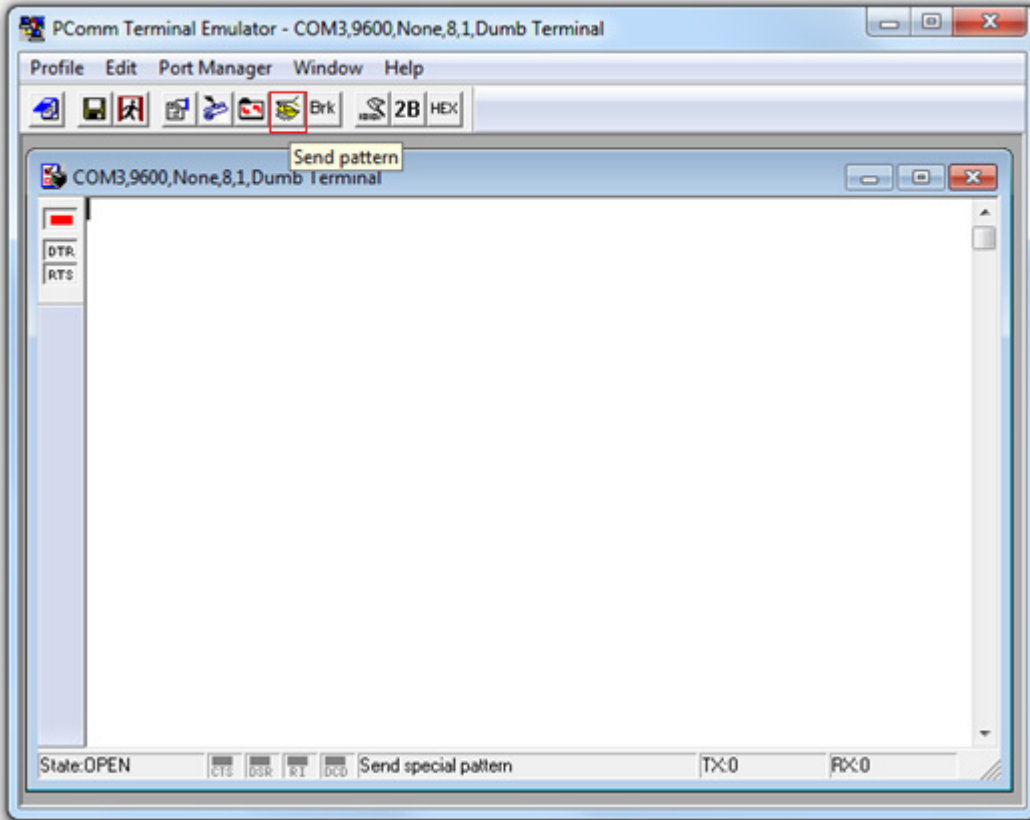

Now you can enter a command in the **HEX** field, and click **Start Send** to send the command. For example, you may send **07FF5357490006**, which queries the firmware version number (a scalar).

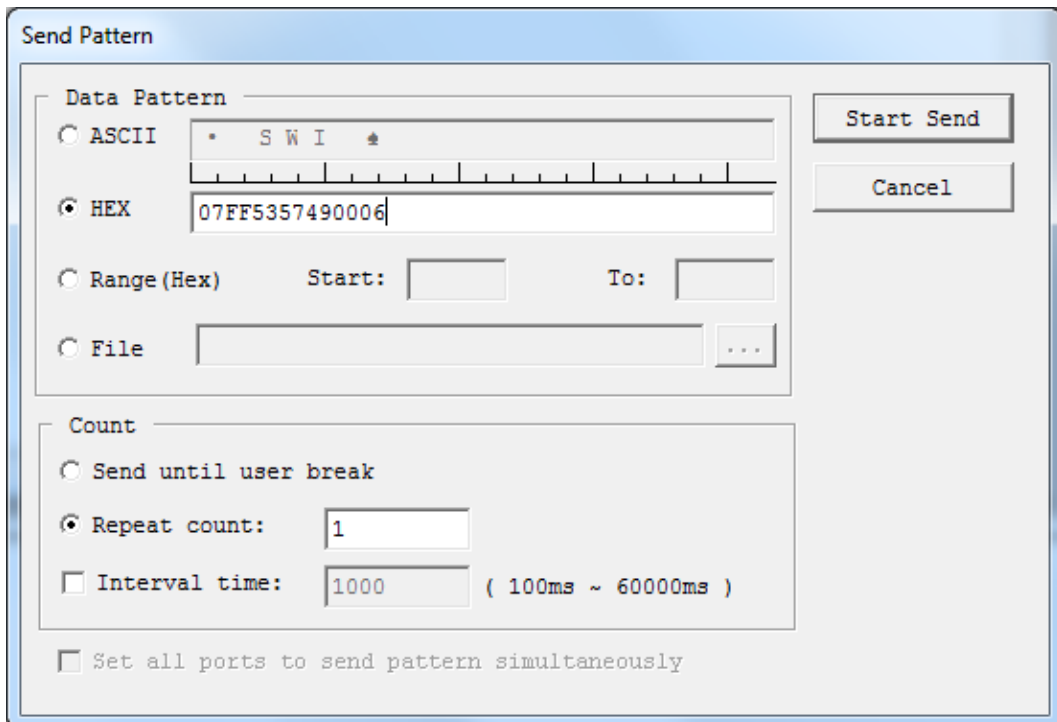

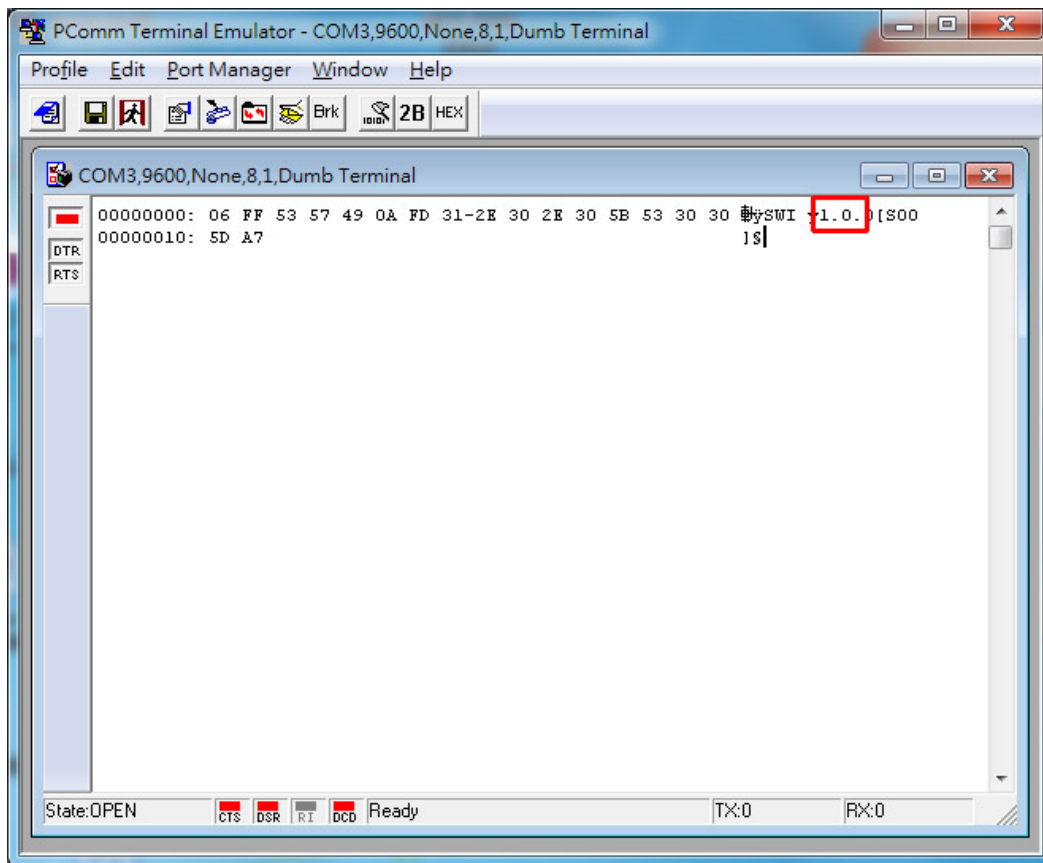

You will now see the firmware version displayed in the terminal (1.0, in the screenshot above). For details about the available commands and how they are used, refer to **Appendix B: Display Control Interface Commands**.

Display Control Interface Command Format

Each command conforms to the following packet structure:

Byte #	0	1	2,3,4	5	6	7, etc	7+LEN
	ATTN	ADDR	CMD	LEN	IHCHK	DATA	IDCHK

The minimal command size is 7 bytes, and the maximal command size is 82 bytes.

Command Format Description

ATTN (Attention)

This byte is used to identify a start of command, and it can be one of three values:

ATTN	Description
0x07	Command (ASCII BELL)
0x06	Acknowledge (ASCII ACK)
0x15	Negative Acknowledge (ASCII NAK)

A device shall send a command using the 0x07 Attention Code. The unit will respond to the command with either an ACK if the command completed successfully, or a NAK if the command failed.

ADDR (Address)

This byte is used to specify a particular unit to receive a command and to identify the unit responding (ACK or NAK) to a command. Please note that MPC-2190 only supports broadcast address. The Address field shall have the following values:

ADDR	Description
0xFF	Broadcast - Addressed to all units

CMD (Message Commands and Queries)

The command can be one of the following values. For details, refer to **Appendix B: Display Control Interface Commands**.

CMD 0	CMD 1	CMD 2	ASCII	Description
0x42	0x52	0x49	"BRI"	Brightness Minimum Value
0x42	0x52	0x4C	"BRL"	Set LED Brightness of Touch Keypad
0x42	0x52	0x4D	"BRM"	Brightness Maximum Value
0x42	0x52	0x54	"BRT"	User Brightness Control
0x42	0x52	0x55	"BRU"	Glass Display Control - Brilliance Button
0x42	0x5A	0x5A	"BZZ"	Buzzer Control
0x44	0x4C	0x4E	"DLN"	Download ECDIS RGB package
0x44	0x4C	0x3F	"DL?"	ECDIS RGB package Query
0x45	0x54	0x43	"ETC"	Elapsed Time Counter Query
0x47	0x4D	0x42	"GMB"	Glass Display Control - Minimum Brightness
0x50	0x4F	0x54	"POT"	Potentiometer Control
0x53	0x57	0x49	"SWI"	Scalar Firmware Version Query
0x53	0x57	0x4B	"SWK"	Touch Keypad Firmware Version Query
0x41	0x44	0x46	"ADF"	AC Input Power Detect Function
0x41	0x44	0x3F	"AD?"	Query AC Input Power Detect Function Status
0x42	0x4C	0x49	"BLI"	Brightness Control
0x44	0x55	0x46	"DUF"	Disable UART Command Function
0x45	0x4D	0x53	"EMS"	ECDIS Mode Select

LEN (Data Length)

This byte defines the length of data in the message in bytes. The maximal value for this field is 74 bytes, and the minimal value is 0 byte.

IHCHK (Inverse Header Checksum)

This is a simple 8-bit checksum of the header data, message bytes 0 to 5. The 8-bit sum (without carry) of bytes 0, 1, 2, 3, 4, 5, and 6 shall be 0xFF.

If a message is received with an incorrect checksum, the display will replay with the attention code set to NAK.

DATA (Data Field)

The data field shall only be transmitted if LEN is larger than 0. This field depends on the CMD transmitted.

IDCHK (Inverse Data Checksum)

These bytes shall be only transmitted if LEN is larger than 0. This is a simple 8-bit checksum of the data field, message bytes 7 to 7+ (LEN-1).

The 8-bit sum (without carry) of bytes 7 through 7+LEN inclusive shall be 0xFF. The receiver will reply to any message that the checksum has failed with the attention code set to NAK.

Downloading RGB Files

Use the following commands for downloading RGB files.

Commands	Description
DL?	Data: none (0 byte) ACK: Total packet numbers (1 byte)
DLN	Data: Appointed packet (1 byte) ACK: File content (30 bytes maximum, except for the last packet)

The command **DL?** will send a request to the micro controller and ask how many packets that need to be downloaded. The reply from the micro controller shall be used when using the command DLN to download the specific packets. Refer to the following section for detailed descriptions of the **DL?** and **DLN**.

Command DL?

Byte Number	Byte 0	Byte 1	Byte 2	Byte 3	Byte 4	Byte 5	Byte 6
Hex	0x7	0xFF	0x44	0x4C	0x3F	0x0	0x2A
ASCII			D	L	?		

Command DLN

Byte Number	Byte 0	Byte 1	Byte 2	Byte 3	Byte 4	Byte 5	Byte 6	Byte 7	Byte 8
Hex	0x7	0xFF	0x44	0x4C	0x4E	0x1	0x1A	0x50	0xAF
ASCII			D	L	N				

Here is the example of downloading the RGB file package 0:

Command to read package 0.

0x07	0xFF	0x44	0x4C	0x4E	0x01	0x1A	0x00	0xFF		
------	------	------	------	------	------	------	------	------	--	--

ACK the package 0 of the first RGB file

0x06	0xFF	0x44	0x4C	0x4E	0x20	0xFC	0x00	-	Data	IDCHK
------	------	------	------	------	------	------	------	---	------	-------

Data should be the real value of the RGB file package 0.

A

Regulatory Approval Statement



This device complies with part 15 of the FCC Rules. Operation is subject to the following two conditions: (1) This device may not cause harmful interference, and (2) this device must accept any interference received, including interference that may cause undesired operation.

Class A : FCC Warning! This equipment has been tested and found to comply with the limits for a Class A digital device, pursuant to part 15 of the FCC Rules. These limits are designed to provide reasonable protection against harmful interference when the equipment is operated in a commercial environment. This equipment generates, uses, and can radiate radio frequency energy and, if not installed and used in accordance with the instruction manual, may cause harmful interference to radio communications. Operation of this equipment in a residential area is likely to cause harmful interference in which case the user will be required to correct the interference at his/her own expense.



European Community

Warning:

This is a **Class A** product. In a domestic environment this product may cause radio interference, in which case the user may be required to take compensatory measures.

Display Control Interface Commands

This chapter defines the serial data format and the serial communication protocol so that engineers can use them to program the MPC-2190 panel computer..

This appendix explains how to use the display control interface commands.

The following topics are covered:

□ Display Control Interface Commands

- BRI (Brightness Minimum Value)
- BRL (Set LED Brightness of Touch Keypad)
- BRM (Brightness Maximum Value)
- BRT (User Brightness Control)
- BRU (Glass Display Control-Brightness Button)
- BZZ (Buzzer Control)
- DLN (Download ECDIS RGB Package)
- DL? (ECDIS RGB Package Query)
- ETC (Elapsed Time Counter Query)
- GMB (Glass Display Control - Minimum Brightness)
- POT (Potentiometer Control)
- SWI (Scalar Firmware Version Query)
- SWK (Touch Keypad Firmware Version Query)
- ADF (AC Input Power Detect Function)
- AD? (Query AC Input Power Detect Function Status)
- BLI (Brightness Control)
- DUF (Disable UART Command Function)
- EMS (ECDIS Mode Select)

Display Control Interface Commands

This section describes the display control interface commands that can be used to configure the display. See the following descriptions.

BRI (Brightness Minimum Value)

This command is to set the brightness minimum value. The range starts from 0x00 to 0x31 (0% - 100%).

LEN=one data byte.

Example :

Command to set 30% brightness.

0x07	0xFF	0x42	0x52	0x49	0x01	0x1B	0x10	0xEF
------	------	------	------	------	------	------	------	------

BRL (Set LED Brightness of Touch Keypad)

This command is to set led brightness value of touch keypad. The range starts from 0x00 to 0x31 (0% - 100%).

The default brightness value of the touch keypad will be changed in the ratio of the panel backlight brightness.

You can send ? to query the current value of the led brightness value. LEN=one data byte.

Example :

Command to set 100% Brightness.

0x07	0xFF	0x42	0x52	0x4C	0x01	0x18	0x31	0xCE
------	------	------	------	------	------	------	------	------

BRM (Brightness Maximum Value)

This command is to set the brightness maximum value. The range starts from 0x00 to 0xFF (0% - 100%).

LEN=one data byte.

Example :

Command to set 88% Brightness.

0x07	0xFF	0x42	0x52	0x4D	0x01	0x17	0xE0	0x1F
------	------	------	------	------	------	------	------	------

BRT (User Brightness Control)

This command is to set maximum brightness of the panel. The range starts from 0x00 to 0xFF (0% - 100%).

The default value is **0xFF**.

Please note whenever the MPC-2190 has been restarted, the BRT value will be reset to 100%. If the BRT value has been changed (the BRT value does not equal to 0xFF), the ECDIS function will not be supported and the ECDIS function keys will be disabled and turned off.

If the data and data checksum of sending are incorrect, the data field of replying is the current BRT value.

LEN=one data byte.

Example :

Command to set 40% Brightness.

0x07	0xFF	0x42	0x52	0x54	0x01	0x10	0x66	0x99
------	------	------	------	------	------	------	------	------

ACK was set to 40% Brightness

0x06	0xFF	0x42	0x52	0x54	0x01	0x11	0x66	0x99
------	------	------	------	------	------	------	------	------

NAK was default Brightness 100%

0x15	0xFF	0x42	0x52	0x54	0x01	0x02	0xFF	0x00
------	------	------	------	------	------	------	------	------

BRU (Glass Display Control-Brightness Button)

This command is to set led brightness value of the touch keypad. The range starts from 0x00 to 0xFF (0% - 100%). The default brightness value of the touch keypad will be changed in the ratio of the panel backlight brightness.

You can send **?** to query the current value of the led brightness value. LEN=one data byte.

Example :

Command to set 100% Brightness.

0x07	0xFF	0x42	0x52	0x55	0x01	0x0F	0xFF	0x00
------	------	------	------	------	------	------	------	------

BZZ (Buzzer Control)

The default value for the buzzer is **OFF**. Users can send this command to turn on/off the buzzer.

If the data and data checksum of sending are incorrect, the data field of replying is current buzzer status.

LEN=one byte.

0x00	Turn the buzzer OFF
0xFF	Turn the buzzer ON

Example :

Turn the buzzer **ON**.

0x07	0xFF	0x42	0x5A	0x5A	0x01	0x02	0xFF	0x00
------	------	------	------	------	------	------	------	------

ACK

0x06	0xFF	0x42	0x5A	0x5A	0x01	0x03	0xFF	0x00
------	------	------	------	------	------	------	------	------

DLN (Download ECDIS RGB Package)

Before sending this command, use **DL?** to know how many available packets in each ECDIS table. This command cannot be used if the MPC-2190 has not been calibrated. Every packet has a head (Byte 7 and Byte 8), Byte 7 is this packet number and Byte 8 is "-" with ASCII, and after the Bytes are data. If packet is full the data is Byte 9 to Byte 38. LEN=one data byte.

Data length is 32. The first byte is package num., the second byte is "-" and the other 30 byte is data.

Example :

Command to read package 0.

0x07	0xFF	0x44	0x4C	0x4E	0x01	0x1A	0x00	0xFF		
------	------	------	------	------	------	------	------	------	--	--

ACK the package 0 of the first RGB file

0x06	0xFF	0x44	0x4C	0x4E	0x20	0xFC	0x00	-	Data	IDCHK
------	------	------	------	------	------	------	------	---	------	-------

DL? (ECDIS RGB Package Query)

Use **DL?** to know how many available packets in each ECDIS table. This command cannot be used if the MPC-2190 has not been calibrated. Total package num = Size of ECDIS RGB file/30 bytes per package.

Example:

Send **DL?** command to query total package num. of the first RGB file.

0x07	0xFF	0x44	0x4C	0x3F	0x00	0x2A
------	------	------	------	------	------	------

ACK 255 packages

0x06	0xFF	0x44	0x4C	0x3F	0x01	0x2A	0xFF	0x00
------	------	------	------	------	------	------	------	------

ETC (Elapsed Time Counter Query)

This command is to query the elapsed time that the MPC-2190 has been operated. The MPC-2190 will reply to this command with an ACK attention code. The largest byte will be transmitted first.

The maximum indicator for this function is 99999 hours (defined into 5 bytes, numbers 0 to 9 each), equivalent to 11 years. If this number is reached, the ETC will stop counting, and the ETC command will always reply with maximum number of hours (99999).

Example:

Send **ETC** to query elapsed time:

0x07	0xFF	0x45	0x54	0x43	0x00	0x1D
------	------	------	------	------	------	------

ACK 99999 hours

06	FF	45	54	43	05	19	39	39	39	39	39	E2
----	----	----	----	----	----	----	----	----	----	----	----	----

GMB (Glass Display Control - Minimum Brightness)

This command is to set the minimum value limit for the brightness of touch keypad LED to make sure that the LED indicators are still visible if they was previously adjusted down to a very low value. The range starts from 0x00 to 0x31 (0% - 100%). LEN=one data byte.

Example :

Command to set 30% Brightness.

0x07	0xFF	0x47	0x4D	0x42	0x01	0x22	0x10	0xEF
------	------	------	------	------	------	------	------	------

POT (Potentiometer Control)

The BR+/BR- key default value is **Enable**. Users can send this command to disable/enable BR+/BR- key. If the data and data checksum of sending are incorrect, the data field of replying is current control status. LEN=one data byte.

0x00	Brightness +/Brightness - Key Disable
0xFF	Brightness +/Brightness - Key Enable

Example :

Disable the BR+/BR- Key.

0x07	0xFF	0x50	0x4F	0x54	0x01	0x05	0x00	0xFF
------	------	------	------	------	------	------	------	------

ACK

0x06	0xFF	0x50	0x4F	0x54	0x01	0x06	0x00	0xFF
------	------	------	------	------	------	------	------	------

SWI (Scalar Firmware Version Query)

This command is to query the scalar firmware version.

Example:

Query Scalar Firmware Version

0x07	0xFF	0x53	0x57	0x49	0x00	0x06
------	------	------	------	------	------	------

SWK (Touch Keypad Firmware Version Query)

This command is to query the touch keypad firmware version.

Example:

Query Touch Keypad Firmware Version

0x07	0xFF	0x53	0x57	0x4B	0x00	0x04
------	------	------	------	------	------	------

ADF (AC Input Power Detect Function)

This default value of this function is **OFF**. If the MPC-2190 supports AC power input, users can turn on this function to detect AC input power when the MPC-2190 has connected to the AC power. LEN=one data byte.

0x00	AC Input Power Detect is OFF
0xFF	AC Input Power Detect is ON

Example :

Set "OFF".

0x07	0xFF	0x41	0x44	0x46	0x01	0x2D	0x00	0xFF
------	------	------	------	------	------	------	------	------

ACK

0x06	0xFF	0x41	0x44	0x46	0x01	0x2E	0x00	0xFF
------	------	------	------	------	------	------	------	------

AD? (Query AC Input Power Detect Function Status)

If the MPC-2190 supports AC power input, users can use command is to query AC Input Power Detect Function Status.

0x00	AC Input Power Detect is OFF
0xFF	AC Input Power Detect is ON

Example :

Send **AD?** command to Query AC Input Power Detect Function Status

0x07	0xFF	0x41	0x44	0x3F	0x00	0x35
------	------	------	------	------	------	------

ACK

0x06	0xFF	0x41	0x44	0x3F	0x01	0x35	0x00	0xFF
------	------	------	------	------	------	------	------	------

BLI (Brightness Control)

This command is to set the panel brightness. Brightness range is from 0x00 to 0xFF. Default Brightness is 160. LEN=one date byte.

Example :

Set brightness to 255(0xFF)

0x07	0xFF	0x42	0x4C	0x49	0x01	0x21	0xFF	0x00
------	------	------	------	------	------	------	------	------

ACK

0x06	0xFF	0x42	0x4C	0x49	0x01	0x22	0xFF	0x00
------	------	------	------	------	------	------	------	------

Query current brightness value

0x07	0xFF	0x42	0x4C	0x49	0x00	0x22
------	------	------	------	------	------	------

ACK

0x06	0xFF	0x42	0x4C	0x49	0x01	0x22	0xFF	0x00
------	------	------	------	------	------	------	------	------

DUF (Disable UART Command Function)

Users can use this command to disable related command control. LEN=one date byte.

DATA	IDCHK	Function description
0x00	0xFF	Disable all command control
0x01	0xFE	Disable BRI control
0x02	0xFD	Disable BRL control
0x04	0xFB	Disable BRM control
0x08	0xF7	Disable BZZ control
0x10	0xEF	Disable ETC control
0x20	0xDF	Disable GMB control
0x40	0xBF	Disable POT control

Example :

Disable all command control

0x07	0xFF	0x44	0x55	0x46	0x01	0x19	0x00	0xFF
------	------	------	------	------	------	------	------	------

ACK

0x06	0xFF	0x44	0x55	0x46	0x01	0x1A	0x00	0xFF
------	------	------	------	------	------	------	------	------

NACK

0x15	0xFF	0x44	0x55	0x46	0x01	0x0B	0x00	0xFF
------	------	------	------	------	------	------	------	------

EMS (ECDIS Mode Select)

For the ECDIS models, users can use this command to switch DAY, DUSK and NIGHT mode. LEN=one date byte.

	DATA	IDCHK
--	------	-------

DAY	0x00	0xFF
DUSK	0x01	0xFE
NIGHT	0x02	0xFD

Example :

Switch to DUSK mode

0x07	0xFF	0x45	0x4D	0x53	0x01	0x13	0x01	0xFE
------	------	------	------	------	------	------	------	------

ACK

0x06	0xFF	0x45	0x4D	0x53	0x01	0x14	0x01	0xFE
------	------	------	------	------	------	------	------	------

NACK

0x15	0xFF	0x45	0x4D	0x53	0x01	0x0B	0x01	0xFE
------	------	------	------	------	------	------	------	------